

Distributed by:



WESTLUND / EMCO
WATER SOLUTIONS



We Are Certified and Award Winning

SPECIALISTS SERVING SPECIALISTS



Westlund Water Solutions is the leading Canadian distributor of pipes, valves, fittings, and all related equipment found 'inside the fence' for wastewater treatment plants, reservoirs, and pumping stations.



Ontario Office: 905-624-4575
Alberta Office: 780-577-8808
WaterSolutions@WestlundPVF.com
www.everythinginsidethefence.com



Distributed by:

WESTLUND / EMCO
WATER SOLUTIONS



SEAMLESS WELDING FITTINGS

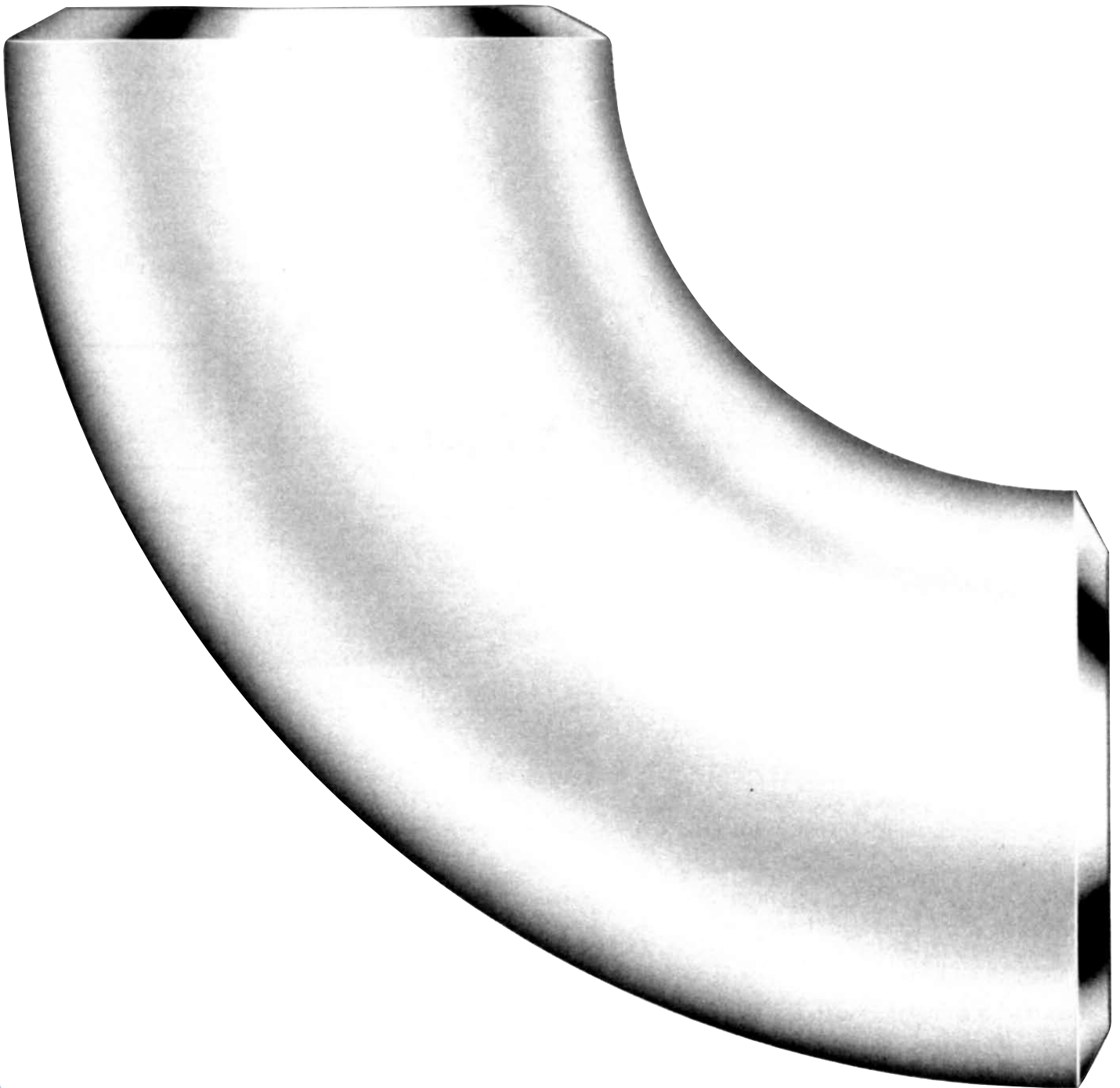





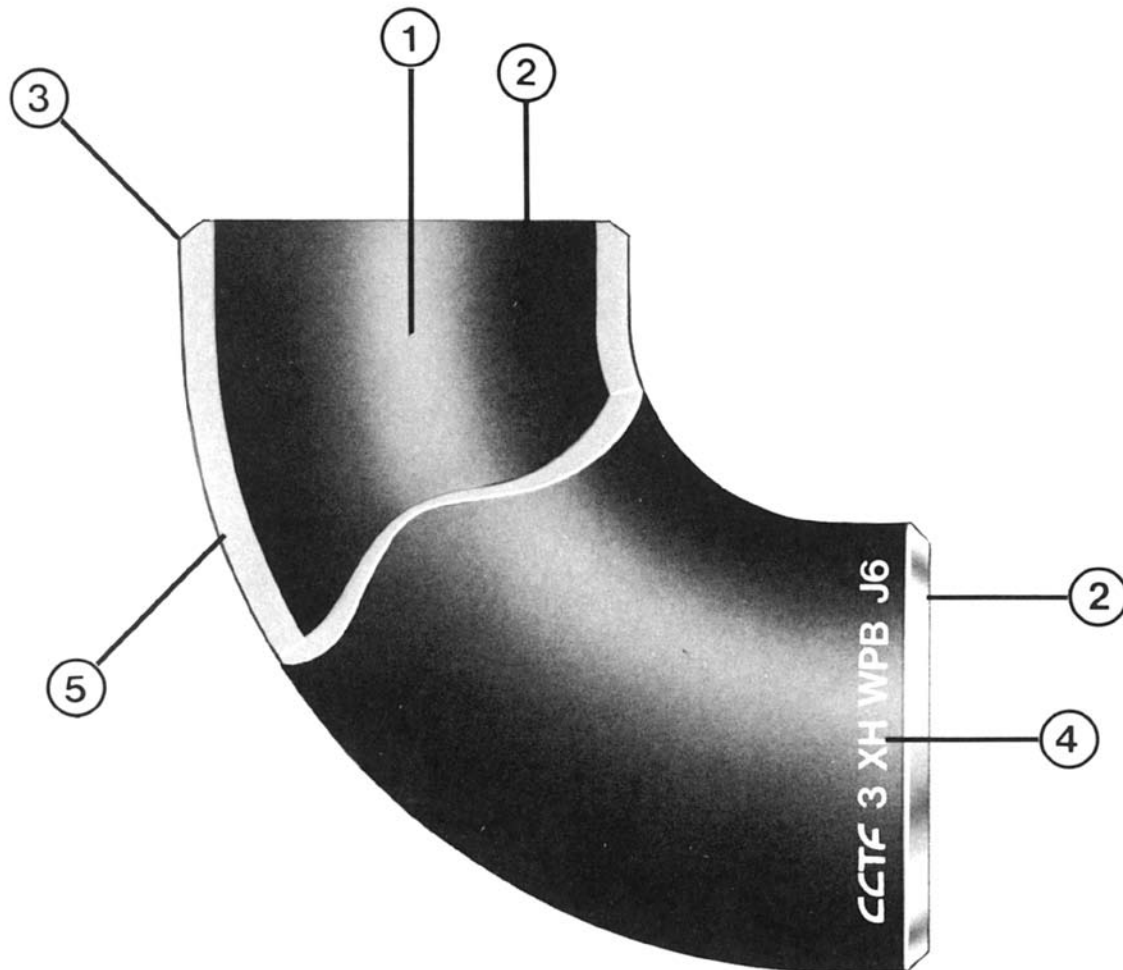







Ontario Office: 905-624-4575
Alberta Office: 780-577-8808
WaterSolutions@WestlundPVF.com
www.everythinginsidethefence.com

INCHES/METRIC

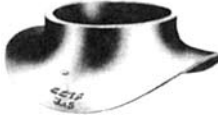

1. True diameter maintained throughout the smooth bore for unrestricted flow.
2. Ends are true and square.
3. Bevels and lands accurately machined for good welding.
4. Clear identification of size, schedule or nominal wall thickness, material and heat code.
5. Full, uniform wall thickness for maximum strength.

Seamless Welding Fittings Index

	90° Elbows Long RadiusPage 8		Reducing Tees and Reducers, Concentric and EccentricPage 16
	90° Reducing Elbows Long RadiusPage 9		CapsPage 20
	90° Elbows Long Radius, Long TangentPage 10		Lap Joint Stub EndsPage 21
	90° Elbows Short RadiusPage 11		SaddlesPage 22
	45° Elbows Long RadiusPage 12		LateralsPage 23
 	180° Returns Long Radius Short RadiusPage 13		Seamless and Welded Pipe, DimensionsPage 6
	Straight Tees and CrossesPage 14, 15		Dimensional Tolerances of FittingsPage 5
			Material and Manufacturing StandardsPage 4
			Butt Welding Ends, Design and DimensionsPage 24

Material and Manufacturing Standards

The manufacture of welding fittings is governed by industry standards established by such associations as 1) the American Society for Testing and Materials (ASTM): 2) the American National Standards Institute (ANSI): 3) the Manufacturer's Standardization Society of the Valve and Fittings Industry (MSS): 4) the Pipe Fabrication Institute (PFI): and 5) the Canadian Standards Association (CSA). They cover specifications for materials, methods of manufacture, dimensions and quality control procedures. All WESTLUND welding fittings conform to one or more of these standards.

ASTM STANDARDS

WESTLUND carbon steel welding fittings are manufactured from seamless steel tubing and furnished in accordance with ASTM Standard A-234, with material specifications in accordance with ASTM A-106, Grade B, for fittings made from pipe; ASTM A-515, Grade 65 or 70, for fittings made from plate.

WESTLUND alloy steel welding fittings are furnished in accordance with ASTM standard A-234, with materials specification including A-335, Grade P1, carbon-molybdenum, and Grade P12, P11, P22, P5, P7; P9 chrome molybdenum, for fittings made from pipe.

ASTM A-204 Grade B, carbon molybdenum, and ASTM A-387 Grades 12, 11, 22, 5, 7, 9 chrome molybdenum for fittings made from plate.

WESTLUND welding fittings are also available in accordance with ASTM specification A-420 covering low-temperature service, down to -150°F (-101°C).

WESTLUND stainless steel welding fittings are manufactured and available in the following types: 304, 304L, 316, 316L and 347. They are furnished in accordance with ASTM Standard A-403, with material specifications to ASTM A-312 covering fittings made from pipe, and A-240 for fittings made from plate. Refer to WESTLUND catalogue "Stainless Steel Welding Fittings."

ANSI, MSS, ASME and CSA Standards

ASME/ANSI and MSS standards govern fitting dimensions and tolerances, ASME/ANSI B16.9 "Wrought Steel Buttwelding Fittings", is the basic standard. It covers steel butt-welding fittings sizes NPS 1/2 through NPS 48 (DN 15 through DN 1200).

Other ASME/ANSI and MSS standards, written to supplement B16.9, are as follows:

ASME/ANSI B16.25:	Butt-welding Ends
ASME/ANSI B16.28:	Butt-welding short radius elbows and returns
MSS SP-43:	Light-wall stainless steel fittings, NPS 3/4 through NPS 24 (DN 20 through DN 600)
MSS SP-75:	High Test Wrought Welding Fittings

The following codes and standards influence the manufacture of welding fittings, where applicable.

ASME/ANSI B31.1:	Power piping
ASME/ANSI B31.3:	Petroleum refinery piping
ASME/ANSI B31.4:	Liquid petroleum transportation piping system
ASME/ANSI B31.5:	Refrigeration piping
ASME/ANSI B31.8:	Gas transmission and distribution piping systems
ANSI/ASME B36.10M:	Welded and seamless wrought steel pipe
ANSI/ASME B36.19M:	Stainless steel pipe
CSA Z183:	Oil pipe line transportation systems
CSA Z184:	Gas pipe line systems
CAN3-Z245.11-M91:	Requirements for wrought steel butt welding fittings
ASME:	Boiler and pressure vessel code

SPECIAL METALS

High Test Steel. High test pipe line welding fittings, conforming to CSA Standard CAN3-Z245.11 or MSS SP-75, are available with physical properties to match pipe with *42,000, 46,000, 52,000, 60,000, 65,000, and over p.s.i. minimum yield strengths.

Other Ferrous Alloys. Fittings are available manufactured from ASTM alloy specifications other than those listed in the "ASTM Standards" above.

Non-Ferrous Metals. Fittings of relatively common metals, such as aluminum, nickel, copper, etc., can be readily furnished; production is limited only by availability of raw materials. The same is true of less common metals, such as the various grades of Hastelloy, Inconel, Incoloy, Monel, Alloy-20, rare types of stainless steel and other unusual analyses.

*Equals 290, 317, 359, 414, 448 Mpa, respectively.

METRIC EQUIVALENTS

The International System (SI) metric equivalent of British units are shown throughout this catalogue.

NPS (Nominal Pipe Size)	= DN, Δ (Nominal Diameter)
Operating Pressure Class	= PN, Δ (Pressure Number)
1 inch	= 25.4 millimetres
1 pound, weight	= 0.4536 kilograms
1 psi	= 0.06895 bars
1 psi, stress	= 0.006895 megapascals (MPa)

Δ From the SI designations, Diamètre Nominal and Pression Nominale.

*DIMENSIONS & TOLERANCES

DIMENSIONAL TOLERANCES

All Fittings				90° & 45° Elbows Tees Crosses Laterals	Caps	180° Returns			Lap-Joint Stub Ends and Reducers	Lap-Joint Stub Ends			
NPS	Outside ¹ Diameter at Bevel O.D.	Inside Diameter at End I.D.	Wall Thickness	Center to End A,B,C,M	Overall Length E	Center to Center H	Back to Face K	Parallely of Planes of Ends	Overall Length F,L	Outside Diameter of Lap G	Thickness of Lap t	Fillet Radius of Lap R	Outside Diameter of Barrel
1/2 - 2 1/2	+0.06 -0.03	±0.03	Not less than 87 1/2% of nominal thickness	±0.06	±.12	±.25	±.25	±.03	±.06	+0 -0.03	+0.06 -0	+0 -0.03	Refer to page 21.
15 - 65	±1	±8		±2	±4	±7	±7	±1	±2	+0 -1	+0.06 -0	+0 -1	
3 - 3 1/2	±0.06	±0.06		±0.06	±.12	±.25	±.25	±.03	±.06	+0 -0.03	+0.06 -0	+0 -0.03	
80 - 90	±1	±1.6		±2	±4	±7	±7	±1	±2	+0 -1	+0.06 -0	+0 -1	
4	±0.06 +2 -1	±0.06		±0.06	±.12	±.25	±.25	±.03	±.06	+0 -0.03	+0.06 -0	+0 -0.06	
100	+2 -1	±1.6		±2	±4	±7	±7	±1	±2	+0 -1	+0.06 -0	+0 -2	
5 - 6	+0.09 -0.06 +3	±0.06		±0.06	±.25	±.25	±.25	±.03	±.06	+0 -0.03	+0.06 -0	+0 -0.06	
125 - 150	+3 -1	±1.6		±2	±7	±7	±7	±1	±2	+0 -1	+0.06 -0	+0 -2	
8	+0.09 -0.06	±0.06		±0.06	±.25	±.25	±.25	±.03	±.06	+0 -0.03	+0.06 -0	+0 -0.06	
200	+2 -1	±1.6		±2	±7	±7	±7	±1	±2	+0 -1	+0.06 -0	+0 -2	
10	+0.16 -0.12 +4	±0.12		±0.09	±.25	±.38	±.25	±.06	±.09	+0 -0.06	+0.06 -0	+0 -0.06	
250	+4 -3	±3.2		±2	±7	±10	±7	±2	±2	+0 -2	+0.06 -0	+0 -2	
12 - 18	+0.16 -0.12 +4	±0.12		±0.09	±.25	±.38	±.25	±.06	±.09	+0 -0.06	+0.06 -0	+0 -0.06	
300 - 450	+4 -3	±3.2		±3	±7	±10	±7	±2	±3	+0 -2	+0.06 -0	+0 -2	
20 - 24	±0.25 -0.19 +6	±0.19		±0.09	±.25	±.38	±.25	±.06	±.09	+0 -0.06	+0.06 -0	+0 -0.06	
500 - 600	-5 +4.8	±4.8		±3	±7	±10	±7	±2	±3	+0 -2	+0.06 -0	+0 -2	
26 - 30	+0.25 -0.19 +7	±0.19	+0.12	+0.38					±.19				
650 - 750	-5 +4.8	±4.8	±3	±10					±5				
32 - 48	±0.25 -0.19 +7	±0.19	±0.19	±.38	±.38				±.19				
800 - 1200	-5 +4.8	±4.8	±5	±10					±5				

¹Out-of-round is the sum of absolute values of plus and minus tolerance.

ANGULARITY TOLERANCES, ASME/ANSI B16.9

ANGULARITY TOLERANCES ±					
Nominal Pipe Size NPS DN	Off Angle Q	Off Plane P	Nominal Pipe Size NPS DN	Off Angle Q	Off Plane P
1/2 - 4	.03	.06	18 - 24	.12	.38
15 - 100	1	2	450 - 600	4	10
5 - 8	.06	.12	26 - 30	.19	.38
125 - 200	2	4	650 - 750	5	10
10 - 12	.09	.19	32 - 34	.19	.50
250 - 300	3	5	800 - 850	5	13
14 - 16	.09	.25	44 - 48	.19	.75
350 - 400	3	7	1125 - 1200	5	20

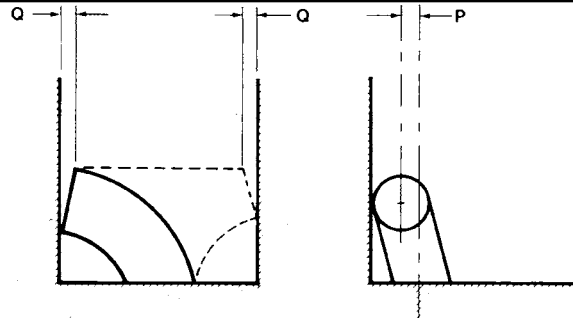

*For design and dimensions of butt welding ends see page 24.

INCHES
MILLIMETRES

***Dimensions of Seamless and Welded Pipe Standards: ASME/ANSI B36.10m
ASME/ANSI B36.19m**

NPS			SCH. 5		SCH. 10		Gas Dist.		SCH. 20		SCH. 30		STD		SCH. 40	
	DN	O.D.	I.D.	Wall	I.D.	Wall	I.D.	Wall	I.D.	Wall	I.D.	Wall	I.D.	Wall	I.D.	Wall
1/8		.405											.269	.068	STD	STD
3	10.3												7.52	1.73	STD	STD
1/4		.540											.364	0.88	STD	STD
6	13.7												9.25	2.24	STD	STD
3/8		.675											.493	.091	STD	STD
10	17.2												12.52	2.31	STD	STD
1/2		.840											.622	.109	STD	STD
15	21.4												15.80	2.77	STD	STD
3/4		1.050	.920	.065	.884	.083							.824	.113	STD	STD
20	26.7	23.37	1.65	22.45	2.11								20.93	2.87	STD	STD
1		1.315	1.185	.065	1.097	.109							1.049	.133	STD	STD
25	33.4	30.10	1.65	27.86	2.77								26.64	3.38	STD	STD
1 1/4		1.660	1.530	.065	1.442	.109							1.380	.140	STD	STD
32	42.2	38.86	1.65	36.63	2.77								35.05	3.56	STD	STD
1 1/2		1.900	1.770	.065	1.682	.109							1.610	.145	STD	STD
40	48.3	44.96	1.65	42.72	2.77								40.89	3.68	STD	STD
2		2.375	2.245	.065	2.157	.109							2.067	.154	STD	STD
50	60.4	57.02	1.65	54.79	2.77								52.50	3.91	STD	STD
2 1/2		2.875	2.709	.083	2.635	.120							2.469	.203	STD	STD
65	73.1	68.81	2.11	66.93	3.05								62.71	5.16	STD	STD
3		3.500	3.334	.083	3.260	.120							3.068	.216	STD	STD
80	88.9	84.68	2.11	82.80	3.05								77.93	5.49	STD	STD
3 1/2		4.000	3.834	.083	3.760	.120							3.548	.226	STD	STD
90	101.6	97.38	2.11	95.50	3.05								90.12	5.74	STD	STD
4		4.500	4.334	.083	4.260	.120	4.124	.188					4.026	.237	STD	STD
100	114.3	110.08	2.11	108.20	3.05	104.75	4.78						102.26	6.02	STD	STD
5		5.563	5.345	.109	5.295	.134							5.047	.258	STD	STD
125	141.3	135.76	2.77	134.49	3.40								128.19	6.55	STD	STD
6		6.625	6.407	.109	6.357	.134	6.187	2.19					6.065	.280	STD	STD
150	168.3	162.74	2.77	161.47	3.40	157.15	5.56						154.05	7.11	STD	STD
8		8.625	8.407	.109	8.329	.148	8.187	.219	8.125	.250	8.071	.277	7.981	.322	STD	STD
200	219.1	213.54	2.77	211.56	3.76	207.95	5.56	206.38	6.35	205.00	7.04	202.72	8.18	STD	STD	
10		10.750	10.482	.134	10.420	.165	10.312	.219	10.250	.250	10.136	.307	10.020	.365	STD	STD
250	273.1	266.24	3.40	264.67	4.19	261.92	5.56	260.35	6.35	257.45	7.80	254.51	9.27	STD	STD	
12		12.750	12.420	.156	12.390	.180	12.250	.250	12.250	.250	12.090	.330	12.000	.375	11.938	406
300	323.9	315.47	3.96	314.71	4.57	311.15	6.35	311.15	6.35	307.09	8.38	304.80	9.53	303.23	10.31	
14		14.000			13.500	.250	13.500	.250	13.376	.312	STD	STD	13.250	.375	13.124	.438
350	355.6				342.90	6.35	342.90	6.35	339.75	7.92	STD	STD	336.55	9.53	333.35	11.12
16		16.000			15.500	.250	15.500	.250	15.376	.312	STD	STD	15.250	.375	XS	XS
400	406.4				393.70	6.35	393.70	6.35	390.55	7.92	STD	STD	387.35	9.53	XS	XS
18		18.000			17.500	.250	17.500	.250	17.376	.312	17.124	.438	17.250	.375	16.876	.562
450	457.2				444.50	6.35	444.50	6.35	441.35	7.92	434.95	11.12	438.15	9.53	428.65	14.27
20		20.000			19.500	.250	19.500	.250	STD	STD	XS	XS	19.250	.375	18.814	.594
500	508.0				495.30	6.35	495.30	6.35	STD	STD	XS	XS	488.95	9.53	477.88	15.09
22		22.000			21.500	.250			STD	STD	XS	XS	21.250	.375		
550	558.8				546.10	6.35			STD	STD	XS	XS	539.75	9.53		
24		24.000			23.500	.250	23.500	.250	STD	STD	22.876	.562	23.250	.375	22.624	.688
600	609.6				596.90	6.35	596.90	6.35	STD	STD	581.05	14.27	590.55	9.53	574.65	17.47
26		26.000			25.376	.312			XS	XS			25.250	.375		
650	660.4				644.55	7.92			XS	XS			641.35	9.53		
28		28.000			27.376	.312			XS	XS	26.750	.625	27.250	.375		
700	711.2				695.35	7.92			XS	XS	679.45	15.88	692.15	9.53		
30		30.000			29.376	.312			XS	XS	28.750	.625	29.250	.375		
750	762.0				746.15	7.92			XS	XS	730.25	15.88	742.95	9.53		
36		36.000			35.376	.312			XS	XS	34.750	.625	35.250	.375	34.500	.750
900	914.4				898.55	7.92			XS	XS	882.65	15.88	895.35	9.53	876.30	19.05
42		42.000									40.750	.625	41.250	.375	40.500	.750
1100	1067										1035.0	15.88	1047.8	9.53	1028.7	19.05
44		44.000											43.250	.375		
-	1118												1098.6	9.56		
46		46.000											42.250	.375		
-	1168												1149.4	9.53		
48		48.000											47.250	.375		
1200	1219												1200.2	9.53		

*Wall dimensions shown are nominal thickness.

INCHES
MILLIMETRES

***Dimensions of Seamless and Welded Pipe Standards: ASME/ANSI B36.10m
ASME/ANSI B36.19m**

SCH. 60		XS		SCH. 80		SCH. 100		SCH. 120		SCH. 140		SCH. 160		XXS		NPS	DN	
I.D.	Wall	I.D.	Wall	I.D.	Wall	I.D.	Wall	I.D.	Wall	I.D.	Wall	I.D.	Wall	I.D.	Wall			
		.215	.095	XS	XS											1/8		
		5.46	2.41	XS	XS											3		
		.302	.229	XS	XS											1/4		
		7.67	3.02	XS	XS											6		
		.423	.126	XS	XS											3/8		
		10.74	3.20	XS	XS											10		
		.546	.147	XS	XS							.464	.188	.252	.294	1/2		
		13.87	3.73	XS	XS							11.79	4.78	6.40	7.47	15		
		.742	.154	XS	XS							.612	.219	4.34	.308	3/4		
		18.85	3.91	XS	XS							15.54	5.56	11.02	7.82	20		
		.957	.179	XS	XS							.815	.250	.599	.358	1		
		24.31	4.75	XS	XS							20.70	6.35	15.21	9.09	25		
		1.278	.191	XS	XS							1.160	.250	.896	.382	1 1/4		
		32.46	4.85	XS	XS							29.46	6.35	22.76	9.70	32		
		1.500	.200	XS	XS							1.338	.281	1.100	.400	1 1/2		
		38.10	5.08	XS	XS							33.99	7.14	27.94	10.16	40		
		1.939	.218	XS	XS							1.687	.344	1.503	.436	2		
		49.25	5.54	XS	XS							42.85	8.74	38.18	11.07	50		
		2.323	.276	XS	XS							2.125	.375	1.771	.552	2 1/2		
		59.00	7.01	XS	XS							53.98	9.53	44.98	14.02	65		
		2.900	.300	XS	XS							2.624	.438	2.300	.600	3		
		73.66	7.62	XS	XS							66.65	11.13	58.42	15.24	80		
		3.364	.318	XS	XS									(1)2.728	(1)6.36	3 1/2		
		85.45	8.08	XS	XS									69.29	16.15	90		
		3.826	.337	XS	XS			.3624	.438			3.438	.531	3.152	.674	4		
		97.18	8.56	XS	XS			92.05	11.13			87.33	13.49	80.06	17.12	100		
		4.813	.375	XS	XS			4.563	.500			4.313	.625	4.063	.750	5		
		122.25	9.53	XS	XS			115.90	12.70			109.55	15.88	103.20	19.05	125		
		5.761	.432	XS	XS			5.501	.562			5.187	.719	4.897	.864	6		
		146.33	10.97	XS	XS			139.73	14.27			131.75	18.26	124.38	21.95	150		
7.813	.406	7.625	.500	XS	XS	7.437	.594	7.187	.719	7.001	.812	6.813	.906	6.875	.875	8		
196.45	10.31	193.68	12.70	XS	XS	188.90	15.09	182.55	18.26	177.83	20.62	173.05	23.01	174.63	22.23	200		
XS	XS	9.750	.500	9.562	.594	9.312	.719	9.062	.844	8.750	1.000	8.500	1.125	SCH. 140		10		
XS	XS	247.65	12.70	242.87	15.09	236.52	18.26	230.17	21.44	222.25	25.40	215.90	28.58	SCH.140		250		
11.626	.582	11.750	.500	11.374	.688	11.062	.844	10.750	1.000	10.500	1.125	10.126	1.312	SCH. 120		12		
295.30	14.27	298.45	12.70	288.90	17.48	280.97	21.44	273.05	25.40	266.70	28.58	257.20	33.32	SCH. 120		300		
12.812	.594	13.000	.500	12.500	.750	12.124	.938	11.812	1.094	11.500	1.250	11.188	1.406			14		
325.42	15.09	330.20	12.70	317.50	19.05	307.95	23.83	300.02	27.79	292.10	31.75	284.18	35.71			350		
14.688	.656	15.000	.500	14.312	.844	13.938	1.031	13.562	1.219	13.124	1.438	12.812	1.594			16		
373.08	16.66	381.00	12.70	363.52	21.44	354.03	26.19	344.47	30.96	333.35	36.53	325.42	40.49			400		
16.500	.750	17.000	.500	16.124	.938	15.688	1.156	15.250	1.375	14.876	1.562	14.438	1.781			18		
419.10	19.05	431.80	12.70	409.55	23.83	398.48	29.36	387.35	34.93	377.85	39.67	366.73	45.24			450		
18.376	.812	19.000	.500	17.938	1.031	17.438	1.281	17.000	1.500	16.500	1.750	16.062	1.969			20		
466.75	20.62	482.60	12.70	455.63	26.19	442.93	32.54	431.80	38.10	419.10	44.45	407.97	50.0			500		
20.250	.875	21.000	.500	19.750	1.225	19.250	1.375	18.750	1.625	18.250	1.875	17.750	2.125			22		
514.35	22.23	533.40	12.70	501.65	28.58	488.95	34.93	476.25	41.28	463.55	47.63	450.85	53.98			550		
22.082	.969	23.00	.500	21.562	1.219	20.938	1.531	20.376	1.812	19.876	2.06	19.312	2.344			24		
560.37	24.61	584.20	12.70	547.67	30.96	531.83	38.89	517.55	46.02	504.85	52.37	490.52	59.54			600		
		25.000	.500														26	
		635.00	12.70														650	
		27.000	.500														28	
		685.80	12.70														700	
		29.000	.500														30	
		736.6	12.70														750	
		35.000	.500														36	
		889.00	12.70														900	
		41.000	.500														42	
		1041.4	12.70														1100	
		43.000	.500														44	
		1092.2	12.70														-	
		45.000	.500														46	
		1143.0	12.70														-	
		4.000	.500														48	
		1193.8	12.70														1200	

(1) Not in ASME/ANSI B36.10M, ASME/ANSI B36.19M

INCHES
MILLIMETRES

90° ELBOW LONG RADIUS

Standard, Extra Strong,
Schedule 160, Double Extra Strong
Carbon and ferritic alloy steel,
ASTM A-234
ASME/ANSI B16.9

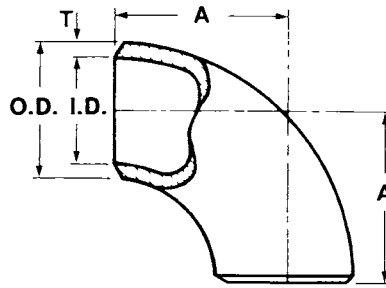

NPS DN	Outside Diameter at Bevel O.D.	Centre to End A	STANDARD WEIGHT			EXTRA STRONG			SCHEDULE 160			DOUBLE EXTRA STRONG		
			Inside Diameter I.D.	Wall Thickness T	Approx. Weight	Inside Diameter I.D.	Wall Thickness T	Approx. Weight	Inside Diameter I.D.	Wall Thickness T	Approx. Weight	Inside Diameter I.D.	Wall Thickness T	Approx. Weight
1/2	.840	1.50	.622	0.109	0.2	.546	.147	0.2	-	-	-	-	-	-
15	21	38	15.80	2.77	0.09	13.87	3.73	.09	-	-	-	-	-	-
3/4	1.050	(1)1.12	.824	0.113	0.3	.742	.154	0.2	-	-	-	-	-	-
20	27	29	20.93	2.87	0.14	18.85	3.91	.09	-	-	-	-	-	-
1	1.315	1.50	1.049	0.133	0.4	.957	.179	0.5	0.815	.250	0.6	.599	.358	0.8
25	33	38	26.64	3.38	0.18	24.31	4.55	0.23	20.7	6.35	0.27	15.21	9.09	0.36
1 1/4	1.660	1.88	1.380	0.140	0.5	1.278	.191	0.7	1.160	.250	1.0	.896	.382	1.4
32	42	48	35.05	3.56	0.23	32.46	4.85	0.32	29.5	6.35	0.45	22.76	9.70	0.63
1 1/2	1.900	2.25	1.610	0.145	0.75	1.500	.200	1.0	1.338	.281	1.8	1.100	.400	2.0
40	48	57	40.89	3.68	0.34	38.10	5.08	0.45	34.0	7.14	0.81	27.94	10.16	0.90
2	2.375	3.0	2.067	0.154	1.5	1.939	.218	2.0	1.687	.344	3.2	1.503	.436	3.8
50	60	76	52.50	3.91	0.68	49.25	5.54	0.9	42.9	8.74	1.44	38.18	11.07	1.71
2 1/2	2.875	3.75	2.469	0.203	3.0	2.323	.276	4.0	2.125	.375	6.0	1.771	.552	7.1
65	73	95	62.71	5.16	1.35	59.00	7.01	1.8	54.0	9.53	2.70	44.98	14.02	3.20
3	3.500	4.50	3.068	0.216	4.5	2.900	.300	6.0	2.624	.438	9.0	2.300	.600	11.2
80	89	114	77.93	5.49	2.03	73.66	7.62	2.7	66.7	11.13	4.05	58.42	15.24	5.04
(2)3 1/2	4.000	5.25	3.548	0.226	6.2	3.364	.318	8.5	-	-	-	(2)2.728	(2).636	16.2
90	102	133	90.12	5.74	2.8	85.45	8.08	3.83	-	-	-	69.29	16.15	7.3
4	4.500	6.00	4.026	0.237	8.5	3.826	.337	12	3.438	.531	19	3.152	.674	21.2
100	114	152	102.26	6.02	3.8	97.18	8.56	5.4	87.3	13.49	8.5	80.06	17.12	9.5
5	5.563	7.50	5.047	0.258	14.2	4.813	.375	20	4.313	.625	33	4.063	.750	38
125	141	190	128.19	6.55	6.4	122.25	9.53	9.0	109.6	15.88	15	103.20	19.05	17
6	6.625	9.00	6.065	0.280	23	5.761	.432	32	5.187	.719	59	4.897	.864	63
150	168	229	154.05	7.11	10.4	146.33	10.97	14	131.8	18.26	27	124.38	21.95	28
8	8.625	12.00	7.981	0.322	45	7.625	.500	68	6.813	.906	127	6.875	.875	120
200	219	305	202.72	8.18	20	193.68	12.70	31	173.05	23.01	57	174.63	22.23	54
10	10.750	15.00	10.02	0.365	78	9.750	.500	112	8.500	1.125	270			
250	273	381	254.5	9.27	35	247.65	12.70	50	215.90	28.58	122			
12	12.750	18.00	12.00	0.375	118	11.750	.500	150	10.126	1.312	460			
300	324	457	304.8	9.53	53	298.45	12.70	68	257.20	33.53	207			
14	14.000	21.0	13.25	0.375	147	13.00	.500	192	11.188	1.406	563			
350	356	533	336.6	9.53	66	330.2	12.70	86	284.18	35.71	253			
16	16.000	24.0	15.25	0.375	202	15.00	.500	258	12.812	1.594	825			
400	406	610	386.1	9.53	91	381.0	12.70	116	325.42	40.49	371			
18	18.000	27.0	17.25	0.375	256	17.00	.500	326						
450	457	686	438.2	9.53	115	431.8	12.70	147						
20	20.000	30.0	19.25	0.375	310	19.00	.500	420						
500	508	62	489.0	9.53	139	482.6	12.70	189						
22	22.000	33.0	21.25	0.375	394	21.00	.500	520						
550	559	838	539.8	9.53	177	533.4	12.70	234						
24	24.000	36.0	23.25	0.375	446	23.00	.500	606						
600	616	914	590.6	9.53	201	584.2	12.70	273						
26	26.000	39.0	25.25	0.375	550	25.00	.500	729						
650	660	991	641.4	9.53	247	635.0	12.70	328						
30	30.000	45.0	29.25	0.375	736	29.00	.500	953						
750	762	1143	743.0	9.53	331	736.6	12.70	429						
36	36.000	54.0	35.25	0.375	1062	35.00	.500	1412						
900	914	1372	895.4	9.53	478	889.0	12.70	635						
42 [△]	42.000	63.0	41.25	0.375	1370	41.00	.500	1890						
1100	1067	1600	1047.8	9.53	616	1041.1	12.70	820						

(1) May be furnished as 1.5 in (38mm) at the manufacturer's option.
 (2) 3-1/2XXS is not specified in ASME/ANSI B36.10M.
 (△) Produced from X-rayed, stress-relieved welded pipe. Welds are 100% radiographed in accordance with the requirements of ASME Boiler & Pressure Vessel Code.
 These fittings are also available in other sizes and/or wall thicknesses.

INCHES	POUNDS
MILLIMETRES	KILOGRAMS

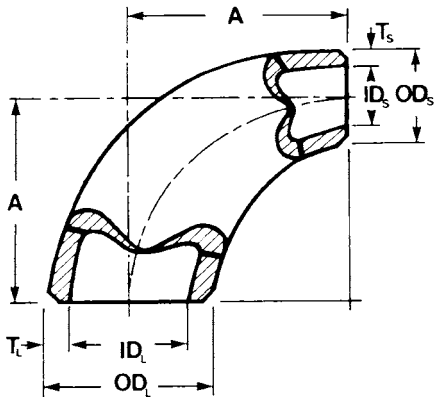

90° REDUCING ELBOWS LONG RADIUS

Standard Weight
and Extra Strong,
(2) Carbon and ferritic alloy steel,
ASTM A-234,
ASME/ANSI B16.9

NPS	Centre to End Nominal A	Standard Approx. Weight	Extra Strong Approx. Weight	NPS	Centre to End Nominal A	Standard Approx. Weight	Extra Strong Approx. Weight	NPS	Centre to End Nominal A	Standard Approx. Weight	Extra Strong Approx. Weight
DN				DN				DN			
2 x 1	3.00	1.10	1.5	6 x 3	9.00	16	24.0	18 x 12	27.0	218	295
50 x 25	76	0.5	0.7	150 x 80	229	7.3	10.8	450 x 300	686	98	133
2 x 1 1/4	3.00	1.20	1.8	6 x 3 1/2	9.00	17	25.5	18 x 14	27.0	230	310
50 x 32	76	0.5	0.8	150 x 90	229	7.7	11.5	450 x 350	686	103	140
2 x 1 1/2	3.00	1.30	2.2	6 x 4	9.00	19	17.0	18 x 16	27.0	240	322
50 x 40	76	0.6	1.0	150 x 100	229	8.6	12	450 x 400	686	108	145
2 1/2 x 1 1/4	3.75	2.10	2.3	6 x 5	9.00	21	31.0	20 x 10	30.0	252	327
65 x 32	95	0.9	1.0	150 x 125	229	9.4	14	500 x 250	762	113	147
2 1/2 x 1 1/2	3.75	2.20	2.5	(2) 8 x 4	12.0	32	48.2	20 x 12	30.0	265	345
65 x 40	95	1.0	1.1	(2) 200 x 100	305	14	22	500 x 300	762	119	155
2 1/2 x 2	3.75	2.45	3.3	8 x 5	12.0	35	53.0	20 x 14	30.0	280	365
65 x 50	95	1.1	1.5	200 x 125	305	16	24	500 x 350	762	126	164
3 x 1 1/2	4.50	3.20	4.3	8 x 6	12.0	40	59.4	20 x 16	30.0	295	390
80 x 40	114	1.4	1.9	200 x 150	305	18	27	500 x 400	762	133	176
3 x 2	4.50	3.50	4.7	10 x 5	15.0	57	78	20 x 18	30.0	310	405
80 x 50	114	1.6	2.1	250 x 125	381	26	35	500 x 450	762	139	182
3 x 2 1/2	4.50	4.15	5.5	10 x 6	15.0	61	86	24 x 12	36.0	345	455
80 x 65	114	1.9	2.5	250 x 150	381	28	39	600 x 300	914	155	205
3 1/2 x 2	5.25	4.50	6.3	10 x 8	15.0	71	101	24 x 14	36.0	360	485
90 x 50	133	2.0	2.8	250 x 200	381	32	45	600 x 350	914	162	218
3 1/2 x 2 1/2	5.25	5.40	7.3	12 x 6	18.0	85	116	24 x 16	36.0	375	500
90 x 65	133	2.4	3.3	300 x 150	457	39	52	600 x 400	914	169	225
3 1/2 x 3	5.25	6.00	8.2	12 x 8	18.0	97	134	24 x 18	36.0	400	520
90 x 80	133	2.7	3.7	300 x 200	457	46	60	600 x 450	914	180	234
4 x 2	6.00	5.95	8.3	12 x 10	18.0	110	149	24 x 20	36.0	415	545
100 x 50	152	2.7	3.7	300 x 250	457	50	67	600 x 500	914	187	245
4 x 2 1/2	6.00	6.70	9.3	14 x 8	21.0	116	152	24 x 22	36.0	430	570
100 x 65	152	3.0	4.2	350 x 200	533	52	68	600 x 550	914	194	257
4 x 3	6.00	7.50	10.4	14 x 10	21.0	126	165	(1) 30 x 16	45.0	605	830
100 x 80	152	3.4	4.7	350 x 250	533	57	74	(1) 750 x 400	1143	272	374
4 x 3 1/2	6.00	8.20	11.3	14 x 12	21.0	138	180	(1) 30 x 18	45.0	620	840
100 x 90	152	3.7	5.1	350 x 300	533	62	81	(1) 750 x 450	1143	279	378
5 x 2 1/2	7.50	10.5	15.5	16 x 10	24.0	155	202	(1) 30 x 20	45.0	635	855
125 x 65	190	4.8	7.1	400 x 250	610	71	93	(1) 750 x 500	1143	292	393
5 x 3	7.50	11.4	16.5	16 x 12	24.0	170	220	(1) 30 x 22	45.0	645	865
125 x 80	190	5.2	7.6	400 x 300	610	78	101	(1) 750 x 550	1143	297	398
5 x 3 1/2	7.50	12.2	17.1	16 x 14	24.0	179	233	(1) 30 x 24	45.0	660	875
125 x 90	190	5.6	7.9	400 x 350	610	82	107	(1) 750 x 600	1143	304	403
5 x 4	7.50	13.1	18.4	18 x 10	27.0	210	280	(1) 30 x 26	45.0	675	890
125 x 100	190	6.0	8.3	450 x 250	686	97	129	(1) 750 x 650	1143	310	409

(1) NPS 30 (DN 750) sizes are not covered by ASME/ANSI B16.9

(2) Sizes NPS 8 (DN 200) and larger may not be supplied as seamless.

These fittings are also available in other sizes and/or wall thicknesses.

INCHES	POUNDS
MILLIMETRES	KILOGRAMS

See page 6 for I.D., and wall thickness (T) for large (L) and small (S) ends.

90° ELBOWS LONG TANGENT

Standard and
Extra Strong
Carbon and ferritic alloy steel,
ASTM A-234

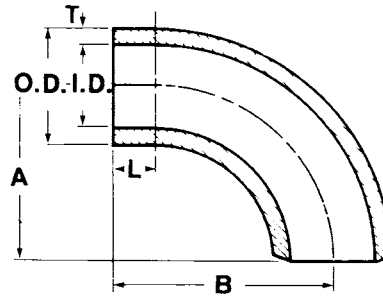

NPS	DN	Outside Diameter at Bevel O.D.	Centre to Short End Nominal A	Tangent Length L	Centre to Long End Nominal B	STANDARD WEIGHT			EXTRA STRONG		
						Wall Thickness T	Inside Diameter I.D.	Approx. Weight	Wall Thickness T	Inside Diameter I.D.	Approx. Weight
1 1/2	40	1.900 48	2.25 57	1.0 25.4	3.25 83	0.145 3.68	1.610 40.89	1.12 0.50	.200 5.08	1.500 38.10	1.45 0.65
2	50	2.375 60	3.0 76	1.25 31.8	4.25 108	0.154 3.91	2.067 52.50	1.94 0.87	.218 5.54	1.939 49.25	2.67 1.20
2 1/2	65	2.875 73	3.75 95	1.25 31.8	5.0 127	0.203 5.16	2.469 62.71	3.63 1.63	.276 7.01	2.323 59.00	4.66 2.10
3	80	3.500 89	4.5 114	1.25 31.8	5.75 146	0.216 5.49	3.068 77.93	5.57 2.5	.300 7.62	2.900 73.66	7.24 3.26
3 1/2	90	4.000 102	5.25 133	1.50 38.1	6.75 171	0.226 5.74	3.548 90.12	7.81 3.5	.318 8.08	3.364 85.45	10.3 4.6
4	100	4.500 114	6.0 152	1.50 38.1	7.5 191	0.237 6.02	4.026 102.26	10.3 4.6	.337 8.56	3.826 97.18	14.4 6.5
5	125	5.563 141	7.5 190	1.50 38.1	9.0 229	0.258 6.55	5.047 128.19	17.1 7.7	.375 9.53	4.813 122.25	24.5 11
6	150	6.625 168	9.0 229	1.75 44.5	10.75 273	0.280 7.11	6.065 154.05	26.4 12	.432 10.97	5.761 146.33	39.7 18
8	200	8.625 219	12.0 305	1.75 44.5	13.75 349	0.322 8.18	7.981 202.72	51.0 23	.500 12.70	7.625 193.68	76.3 34
10	250	10.750 273	15.0 381	2.0 50.8	17.0 432	0.365 9.27	10.020 254.51	89.5 40	.500 12.70	9.750 247.65	118.0 53
12	300	12.750 324	18.0 457	2.5 63.5	20.5 521	0.375 9.53	12.000 304.80	133.0 60	.500 12.70	11.750 298.45	171.0 77

* Tangent end is supplied square unless otherwise specified.

Short end is supplied with standard bevel. ASME/ANSI B16.25.

Dimensional tolerances conform with ASME/ANSI B16.9 (see page 5).

Wall thicknesses conform with ASME/ANSI B36.10M (see page 6).

These fittings are also available in other sizes and/or wall thicknesses.

INCHES	POUNDS
MILLIMETRES	KILOGRAMS

90° ELBOWS SHORT RADIUS

Standard Weight, Extra Strong,
and Double Extra Strong
Carbon and ferritic alloy steel,
ASME/ANSI B16.28,
ASTM A-234

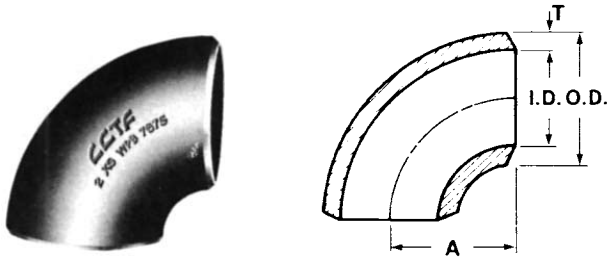

NPS DN	Outside Diameter at Bevel O.D.	Centre to End Nominal A	STANDARD WEIGHT			EXTRA STRONG			DOUBLE EXTRA STRONG		
			Inside Diameter I.D.	Wall Thickness T	Approx. Weight	Inside Diameter I.D.	Wall Thickness T	Approx. Weight	Inside Diameter I.D.	Wall Thickness T	Approx. Weight
1	1.315	1.0	1.049	.133	.25	-	-	-	-	-	-
25	33	25	26.64	3.38	.11	-	-	-	-	-	-
1 1/4	1.660	1.25	1.380	.140	.38	-	-	-	-	-	-
32	42	32	35.05	3.56	.17	-	-	-	-	-	-
1 1/2	1.900	1.5	1.610	.145	.50	1.500	.200	.75	1.100	.400	1.5
40	48	38	40.89	3.68	.23	38.10	5.08	.34	27.94	10.16	.68
2	2.375	2.0	2.067	.154	.88	1.939	.218	1.50	1.503	.436	2.8
50	60	51	52.50	3.91	.40	49.25	5.54	.68	38.13	11.07	1.26
2 1/2	2.875	2.5	2.469	.203	1.75	2.323	.276	2.25	1.771	.552	4.9
65	73	64	62.71	5.16	.79	59.00	7.01	1.01	44.98	14.02	2.21
3	3.500	3.0	3.068	.216	3.00	2.900	.300	3.75	2.300	.600	7.0
80	89	76	77.93	5.49	1.35	73.66	7.62	1.69	58.42	15.24	3.15
3 1/2	4.000	3.5	3.548	.226	4.00	3.364	.318	5.50	(1)2.728	(1).636	10.5
90	102	89	90.12	5.74	1.80	85.45	8.08	2.48	69.29	16.15	4.73
4	4.500	4.0	4.026	.237	6.00	3.826	.337	7.75	3.152	.674	14.1
100	114	102	102.26	6.02	2.70	97.18	8.56	3.5	80.06	17.12	6.35
5	5.563	5.0	5.047	.258	9.5	4.813	.375	13.5	4.063	.750	26
125	141	127	128.19	6.55	4.28	122.25	9.53	6.1	103.20	19.05	12
6	6.625	6.0	6.065	.280	15.5	5.761	.432	22.5	4.897	.864	43
150	168	152	154.05	7.11	7	146.33	10.97	10.1	124.38	21.95	19.4
8	8.625	8.0	7.981	.322	31	7.625	.500	46	6.875	.875	80
200	219	203	202.72	8.18	14	193.68	12.70	21	174.63	22.23	36
10	10.750	10.0	10.02	.365	55	9.750	.500	71			
250	273	254	254.5	9.27	25	147.65	12.70	32			
12	12.750	12.0	12.00	.375	78	11.750	.500	100			
300	324	305	304.8	9.53	35	298.45	12.70	45			
14	14.000	14.0	13.25	.375	104	13.00	.500	132			
350	356	356	336.6	9.53	47	330.02	12.70	59			
16	16.000	16.0	15.25	.375	118	15.00	.500	160			
400	406	406	387.4	9.53	53	381.0	12.70	72			
18	18.000	18.0	17.25	.375	148	17.00	.500	160			
450	457	457	438.2	9.53	67	431.8	12.70	87			
20	20.000	20.0	19.25	.375	210	19.00	.500	280			
500	508	508	489.0	9.53	95	482.6	12.70	126			
24	24.000	24.0	23.25	.375	288	23.00	.500	370			
600	610	610	590.6	9.53	130	584.2	12.70	167			
(2)30	30.000	30.0	29.25	.375	480	29.00	.500	634			
(2)750	762	762	743.0	9.53	216	736.6	12.70	285			
(2)36	36.000	36.0	35.25	.375	695	35.00	.500	940			
(2)900	914	914	895.4	9.53	313	889.0	12.70	423			

(1) NPS 3-1/2 (DN 90) XXS is not specified in ASME/ANSI B36.10.

(2) These sizes not covered in ASME/ANSI B16.28.

These fittings are also available in other sizes and/or wall thicknesses.

INCHES	POUNDS
MILLIMETRES	KILOGRAMS

45° ELBOWS LONG RADIUS

Standard Weight,
Extra Strong, Schedule 160,
Double Extra Strong
Carbon and ferritic alloy steel,
ASTM A-234, ASME/ANSI B16.9

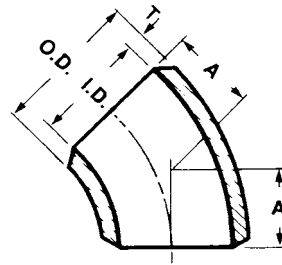

NPS	DN	Outside Diameter at Bevel O.D.	Centre to End Nominal A	STANDARD WEIGHT			EXTRA STRONG			SCHEDULE 160			DOUBLE EXTRA STRONG		
				Inside Diameter I.D.	Wall Thickness T	Approx. Weight	Inside Diameter I.D.	Wall Thickness T	Approx. Weight	Inside Diameter I.D.	Wall Thickness T	Approx. Weight	Inside Diameter I.D.	Wall Thickness T	Approx. Weight
1/2		.840	.62	.622	.109	.08	-	-	-	-	-	-	-	-	-
	15	21	16	15.80	2.77	.04	-	-	-	-	-	-	-	-	-
3/4		1.050	.44	.824	.113	.08	.742	.154	.16	-	-	-	.434	.308	0.17
	20	27	11	20.93	2.87	.04	18.85	3.91	.07	-	-	-	11.02	7.82	.08
1		1.315	.88	1.049	.133	.25	.957	.179	.28	.815	.250	.38	.599	.358	.40
	25	33	22	26.24	3.38	.11	24.31	4.55	.13	20.70	6.35	.17	15.21	9.09	.18
1 1/4		1.660	1.00	1.380	.140	.33	1.278	.191	.44	1.160	.250	.50	.896	.382	.55
	32	42	25	35.05	3.56	.15	32.46	4.85	.20	29.46	6.35	.23	22.76	9.70	.25
1 1/2		1.900	1.12	1.610	.145	.47	1.500	.200	.60	1.338	.281	1.00	1.100	.400	1.15
	40	48	29	40.89	3.68	.21	38.10	5.08	.27	34.0	7.14	.45	27.94	10.16	.52
2		2.375	1.38	2.067	.154	.78	1.939	.218	1.05	1.687	.344	1.75	1.503	.436	2.13
	50	60	35	52.50	3.91	.35	49.25	5.54	.47	42.85	8.74	.79	38.18	11.07	.96
2 1/2		2.875	1.75	2.469	.203	1.66	2.323	.276	1.91	2.125	.375	3.00	1.771	.552	3.75
	65	73	44	62.71	5.16	.75	59.00	7.01	.86	53.98	9.53	1.35	44.98	14.02	1.7
3		3.500	2.00	3.068	.216	2.25	2.900	.300	3.08	2.624	.438	4.5	2.300	.600	5.75
	80	89	51	77.93	5.49	1.01	73.66	7.62	1.39	66.65	11.13	2.0	58.42	15.24	2.6
3 1/2		4.000	2.25	3.548	.226	3.16	3.364	.318	4.75	-	-	-	*2.728	*.636	8.65
	90	102	57	90.12	5.74	1.42	85.45	8.08	2.14	-	-	-	69.29	16.15	3.9
4		4.500	2.50	4.026	.237	4.25	3.826	.337	5.88	3.428	.531	9.5	3.152	.674	10.7
	100	114	64	102.26	6.02	1.91	97.18	8.56	2.65	87.33	13.49	4.3	80.06	17.12	4.8
5		5.563	3.12	5.047	.258	7.25	4.813	.375	10.0	4.313	.625	4.3	4.063	.750	19
	125	141	79	128.19	6.55	3.26	122.25	9.53	4.65	109.55	15.88	7.65	103.20	19.05	8.6
6		6.625	3.75	6.065	.280	11.5	5.761	.432	16.7	5.187	.719	30	4.897	.864	32
	150	168	95	154.05	7.11	5.18	146.33	10.97	7.5	131.8	18.26	13.5	124.38	21.95	14.4
8		8.625	5.00	7.981	.322	22.5	7.625	.500	34	6.813	.906	64	6.875	.875	60
	200	219	127	202.72	8.18	10	193.68	12.70	15	173.05	23.01	29	174.63	22.23	27
10		10.750	6.25	10.02	.365	39	9.750	.500	53	8.500	1.125	135	-	-	-
	250	273	150	254.5	9.27	18	247.65	12.70	24	215.9	28.58	61	-	-	-
12		12.750	7.50	12.00	.375	59	11.750	.500	74	10.126	1.312	230	-	-	-
	300	324	190	304.8	9.53	27	298.45	12.70	33	257.2	33.32	104	-	-	-
14		14.000	8.75	13.25	.375	74	13.00	.500	95	11.188	1.406	278	-	-	-
	350	356	222	336.6	9.53	33	330.2	12.70	43	284.2	35.71	125	-	-	-
16		16.000	10.00	15.25	.375	101	15.00	.500	131	12.812	1.594	415	-	-	-
	400	406	254	387.4	9.53	46	381.0	12.70	59	325.4	40.49	187	-	-	-
18		18.000	11.25	17.25	.375	128	17.00	.500	170						
	450	457	286	438.2	9.53	5	431.8	12.70	77						
20		20.000	12.50	19.25	.375	155	19.00	.500	205						
	500	508	318	489.0	9.53	70	482.6	12.70	92						
22		22.000	13.50	21.25	.375	197	21.00	.500	260						
	550	559	343	539.8	9.53	89	533.4	12.70	117						
24		24.000	15.00	23.25	.375	223	23.00	.500	295						
	600	610	381	590.6	9.53	100	584.2	12.70	133						
26		26.000	16.00	25.25	.375	275	25.00	.500	365						
	650	660	406	641.4	9.53	124	635.0	12.70	164						
30		30.000	18.50	29.25	.375	367	29.00	.500	475						
	750	762	470	743.0	9.53	165	736.6	12.70	214						
36		36.000	22.25	35.25	.375	531	35.00	.500	706						
	900	914	565	895.4	9.53	239	889.0	12.70	318						
42 [△]		42.000	26.00	41.25	.375	710	41.00	.500	950						
	1100	1067	860	1047.8	9.53	320	1041.4	12.70	428						

* NPS 3-1/2 (DN 90) XXS is not specified in ASME/ANSI B36.10M.

[△] Produced from x-rayed, stress relieved welded pipe. Welds are 100% radiographed in accordance with the requirements of ASME Boiler & Pressure Vessel Code.

These fittings are also available in other sizes and/or wall thicknesses.

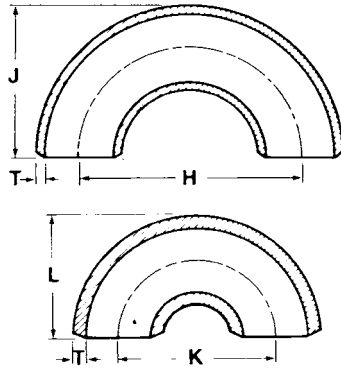

180° RETURNS LONG RADIUS SHORT RADIUS

Standard Weight & Extra Strong
Carbon and ferritic alloy steel, ASTM A-234,
ASME/ANSI B16.9
ASME/ANSI B16.28

NPS	DN	Outside Diameter O.D.	LONG RADIUS		SHORT RADIUS		STANDARD WEIGHT				EXTRA STRONG			
			Center to Center Nominal H	Back to Face Nominal J	Center to Center Nominal K	Back to Face Nominal L	Inside Diameter I.D.	Wall Thickness T	Long Radius Approx. Weight	Short Radius Approx. Weight	Inside Diameter I.D.	Wall Thickness T	Long Radius Approx. Weight	Short Radius Approx. Weight
1/2	15	.840	.300	1.88	(1) -	-	.622	.109	.25	(1) -	.546	.147	.45	(1) -
		21	76	48	(1) -	-	15.80	2.77	.11	(1) -	13.87	3.73	.20	(1) -
3/4	20	1.050	2.25	1.69	(1) -	-	.824	.113	.33	(1) -	.742	.154	.45	(1) -
		27	57	43	(1) -	-	20.93	2.87	.15	(1) -	18.85	3.91	.20	(1) -
1	25	1.315	3.00	2.19	2.0	1.62	1.049	.133	.75	.50	.957	.179	1.0	(1) -
		33	76	56	51	41	26.64	3.38	.34	.23	24.31	4.55	.45	(1) -
1 1/4	32	1.660	3.75	2.75	2.5	2.06	1.380	.140	1.0	.75	1.278	.191	1.5	(1) -
		42	95	70	64	52	35.05	3.56	.45	.34	32.46	4.85	.68	(1) -
1 1/2	40	1.900	4.50	3.25	3.0	2.44	1.610	.145	1.5	1.0	1.500	.200	2.0	1.5
		48	114	83	76	62	40.89	3.68	.68	.45	38.10	5.08	.90	.68
2	50	2.375	6.00	4.19	4.0	3.19	2.067	.154	3.0	1.8	1.939	.213	4.4	3.0
		60	152	106	102	81	52.50	3.91	1.35	.81	49.25	5.54	2.0	1.35
2 1/2	65	2.875	7.50	5.19	5.0	3.94	2.469	.203	6.0	3.5	2.323	.276	7.5	4.5
		73	191	132	127	100	62.71	5.16	2.70	1.58	59.00	7.01	3.38	2.03
3	80	3.500	9.00	6.25	6.0	4.75	3.068	.216	9.0	6.0	2.900	.300	12.0	7.5
		89	229	159	152	121	77.93	5.49	4.05	2.70	73.66	7.62	5.40	3.38
3 1/2	90	4.000	10.50	7.25	7.0	5.5	3.548	.226	12.5	8.0	3.364	.318	17.0	11.0
		102	267	184	178	140	90.12	5.74	5.63	3.60	85.45	8.08	7.65	5
4	100	4.500	12.0	8.25	8.0	6.25	4.026	.237	17.0	12.0	3.826	.337	23.5	15.5
		114	305	210	203	159	102.26	6.02	7.65	5.40	97.18	8.56	10.6	7
5	125	5.563	15.0	10.31	10.0	7.75	5.047	.258	28.5	19.0	4.813	.375	40.0	27.0
		141	381	262	254	197	128.19	6.55	12.83	8.55	122.25	9.53	18	12
6	150	6.625	18.0	12.31	12.0	9.31	6.065	.280	46	31.0	5.761	.432	67	45.0
		168	457	313	305	237	154.05	7.11	20.70	14	146.33	10.97	30	20
8	200	8.625	24.0	16.31	16.0	12.31	7.981	.322	90	62	7.625	.500	138	92
		219	610	414	406	313	202.72	8.18	40.50	28	193.68	12.70	62	41
10	250	10.750	30.0	20.38	20.0	15.38	10.02	.365	156	110	9.750	.500	215	142
		273	762	518	508	391	254.5	9.27	70.20	49.5	247.65	12.70	62	41
12	300	12.750	36.0	24.38	24.0	18.38	12.00	.375	236	156	11.750	.500	300	200
		324	914	619	610	467	304.8	9.53	106.20	70	298.45	12.70	135	90
14	350	14.000	42.0	28.0	28.0	21.0	13.25	.395	294	208	13.00	.500	376	264
		356	1067	711	711	533	336.6	9.53	132.30	94	330.2	12.70	236	144
16	400	16.000	48.0	32.0	32.0	24.0	15.25	.375	404	236	15.00	.500	524	320
		406	1219	813	813	610	387.4	9.53	181.80	106	381.0	12.70	236	144
18	450	18.000	54.0	36.0	36.0	27.0	17.25	.375	512	296	17.00	.500	676	388
		457	1372	914	914	686	438.2	9.53	230.4	133	431.8	12.70	304	175
20	500	20.000	60.0	40.0	40.0	30.0	19.25	.375	617	420	19.00	.500	824	560
		508	1524	1018	1016	762	489.0	9.53	277.7	189	482.6	12.70	371	252
22	550	22.000	66.0	44.0	(2) -	-	21.25	.375	787	(2) -	21.00	.500	1040	(2) -
		559	1676	1118	(2) -	-	539.8	9.53	354.2	(2) -	533.4	12.70	468	(2) -
24	600	24.000	72.0	48.0	48.0	36.0	23.25	.375	890	576	23.00	.500	1183	740
		610	1829	1219	1219	914.4	590.6	9.53	400.5	259	584.2	12.70	468	(2) -
(3)26	(3)650	26.000	78.0	52.0	(2) -	-	25.25	.375	1100	(2) -	25.00	.500	1458	(2) -
		660	1981	1321	(2) -	-	641.4	9.53	495.0	(2) -	635.0	12.70	656	(2) -
(3)30	(3)750	30.000	90.0	60.0	60.0	45.0	29.25	.375	1441	960	29.00	.500	1910	1272
		762	2286	1524	1524	1143	743.0	9.53	648.5	432	736.6	12.70	860	572

(1) These sizes of Short Radius Returns are not available.

(2) Available by special order only.

(3) These sizes not covered by ASME/ANSI B16.9 or ASME/ANSI B16.28.

Particulars and specifications of Long Radius, Sch. 160 and XXS, and Short Radius XXS available on request.

These fittings are also available in other sizes and/or wall thicknesses.

INCHES	POUNDS
MILLIMETRES	KILOGRAMS

STRAIGHT TEES & CROSSES*

Standard Weight and

Extra Strong

Carbon and ferritic alloy steel,

ASTM A-234, ASME/ANSI B16.9

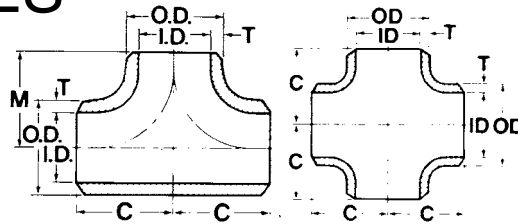

NPS	DN	Outside Diameter O.D.	Centre to End, Run. C	Center to End, Outlet M	STANDARD WEIGHT				EXTRA STRONG			
					Inside Diameter I.D.	Wall Thickness T	Approx. Weight Tee	Approx. Weight Cross	Inside Diameter I.D.	Wall Thickness T	Approx. Weight Tee	Approx. Weight Cross
1/2		.840	1.00	1.00	.622	.109	.25	-	.546	.147	.34	-
	15	21	25	25	15.80	2.77	.11	-	.187	3.73	.15	-
3/4		1.050	1.12	1.12	.824	.113	.37	-	.742	.154	.44	-
	20	27	29	29	20.93	2.87	.17	-	18.85	3.91	.2	-
1		1.315	1.50	1.50	1.049	.133	.63	-	.957	.179	.8	-
	25	33	38	38	26.64	3.38	.28	-	24.31	4.55	.36	-
1 1/4		1.660	1.88	1.88	1.380	.140	1.25	1.60	1.278	.191	1.6	2.20
	32	42	48	48	35.05	3.56	.57	.72	32.46	4.85	.73	.99
1 1/2		1.900	2.25	2.25	1.610	.145	1.5	2.10	1.500	.200	2.0	2.60
	40	48	57	57	40.89	3.68	.68	.95	38.10	5.08	.9	1.17
2		2.375	2.50	2.50	2.067	.154	2.0	2.55	1.939	.218	3.0	3.25
	50	60	64	64	52.50	3.91	.9	1.15	49.25	5.54	1.3	1.46
2 1/2		2.875	3.00	3.00	2.469	.203	4.0	3.40	2.323	.276	5.7	4.15
	65	73	76	76	62.71	5.16	1.8	1.53	59.00	7.01	2.6	1.87
3		3.500	3.38	3.38	3.068	.216	6.0	4.10	2.900	.300	7.7	6.20
	80	89	86	86	77.93	5.49	2.7	1.85	73.66	7.62	3.5	2.79
3 1/2		4.000	3.75	3.75	3.548	.226	7.5	5.65	3.364	.318	10.0	9.50
	90	102	95	95	90.12	5.74	3.4	2.54	85.45	8.08	.45	4.28
4		4.500	4.12	4.12	4.026	.237	10.2	9.25	3.826	.337	14	12.7
	100	114	105	105	102.3	6.02	4.6	4.16	97.18	8.56	6.3	5.72
5		5.563	4.88	4.88	5.047	.258	16	11.20	4.813	.375	23	18.0
	125	141	125	125	128.2	6.55	7.3	5.04	122.2	9.53	10.4	9.1
6		6.625	5.62	5.62	6.065	.280	23.5	25.0	5.761	.432	38.2	31.5
	150	188	143	143	154.0	7.11	10.7	11	146.3	10.97	17	14
8		8.625	7.00	7.00	7.981	.322	44.8	41.5	7.625	.500	67	52.0
	200	218	178	178	202.7	8.18	20	19	193.7	12.70	30	24
10		10.750	8.50	8.50	10.02	.365	74.2	72	9.750	.500	110	85.0
	250	273	216	216	254.5	9.27	34	32	247.6	12.70	50	38
12		12.750	10.0	10.0	12.00	.375	126	96	11.750	.500	165	130
	300	324	254	254	304.8	9.53	56.70	43	298.4	12.70	74	59
14		14.000	11.0	11.0	13.25	.375	159	121	13.00	.500	225	145
	350	356	279	279	336.6	9.53	71.55	54	330.2	12.70	101	65
16		16.000	12.0	12.0	15.25	.375	220	145	15.00	.500	265	180
	400	406	305	305	387.4	9.53	99.0	65	381.0	12.70	119	81
18		18.000	13.5	13.5	17.25	.375	295	170	17.00	.500	358	210
	450	457	343	343	438.2	9.53	132.8	77	431.8	12.70	161	95
20		20.000	15.0	15.0	19.25	.375	363	195	19.00	.500	358	210
	500	508	381	381	489.0	9.53	163.4	88	482.6	12.70	161	95
22		22.000	16.5	16.5	21.25	.375	449	-	21.00	.500	540	-
	550	559	419	419	539.8	9.53	202	-	533.4	12.70	243	-
24		24.000	17.0	17.0	23.25	.375	515	230	23.00	.500	625	300
	600	10	432	590.6	9.53	259	103	584.2	12.70	281	135	-
26		26.000	19.5	19.5	25.25	.375	655	-	25.00	.500	840	-
	650	860	495	495	641.4	9.53	295	-	635.0	12.70	378	-
30		30.000	22.0	22.0	29.25	.375	1010	-	29.00	.500	1175	-
	750	762	559	559	743.0	9.53	455	-	736.6	12.70	529	-
36		36.000	26.5	26.5	35.25	.375	1450	-	35.00	.500	1650	-
	900	914	673	673	895.4	9.53	653	-	889.0	12.70	743	-
42		42.000	30.0	28.0	41.25	.375	1730	-	41.00	.500	1970	-
	1100	1067	762	711	1048	9.53	779	-	1041	12.70	887	-

Tees size 20 NPS (DN 500) and smaller, and Crosses size 16 NPS (DN 400) and smaller, are normally furnished as seamless. Larger size non-seamless Tees and Crosses are produced from X-rayed, stress relieved welded pipe. Welds are 100% radiographed in accordance with the requirements of ASME Boiler & Pressure Vessel Code.

*Reduced outlet crosses available on request. These fittings are also available in other sizes and/or wall thicknesses.

INCHES	POUNDS
MILLIMETRES	KILOGRAMS

STRAIGHT TEES

Schedule 160 &
Double Extra Strong
Carbon and ferritic alloy steel,
ASTM A-234,
ASME/ANSI B16.9

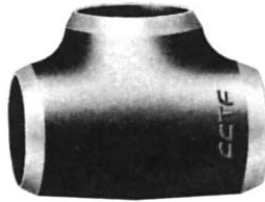
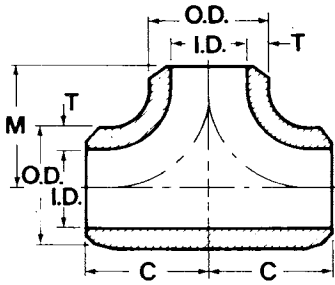

NPS	DN	Outside Diameter at Bevel O.D.	Centre to End, Run. Nominal C	Center to End, Outlet. Nominal M	SCHEDULE 160			DOUBLE EXTRA STRONG		
					Inside Diameter I.D.	Wall Thickness T	Approx. Weight	Inside Diameter I.D.	Wall Thickness T	Approx. Weight
3/4	20	1.050 27	1.12 29	1.12 29	.612 15.54	.219 5.6	.65 .29	.434 11.02	.308 7.82	1.16 .52
1	25	1.315 33	1.50 38	1.50 38	.815 20.70	.250 6.35	1.10 .50	.599 15.21	.358 9.09	1.25 .56
1 1/4	32	1.660 42	1.88 48	1.88 48	1.160 29.46	.250 6.35	2.10 .95	.896 22.76	.382 9.70	2.32 1.04
1 1/2	40	1.900 48	2.25 57	2.25 57	1.338 33.99	.281 7.14	3.00 1.35	1.100 27.94	.400 10.16	3.38 1.52
2	50	2.375 60	2.50 64	2.50 64	1.687 42.85	.344 8.74	4.5 2.03	1.503 38.18	.436 11.07	5.20 2.34
2 1/2	65	2.875 73	3.00 76	3.00 76	2.125 53.98	.375 9.53	7.0 3.15	1.771 44.98	.552 14.02	9.63 4.33
3	80	3.500 89	3.38 86	3.38 86	2.624 66.65	.438 11.13	11.5 5.18	2.300 58.42	.600 15.24	13.5 6.08
3 1/2	90	4.000 102	3.75 95	3.75 95	- -	- -	- -	2.728 69.29	.636 16.15	23 10.35
4	100	4.500 114	4.12 105	4.12 105	3.438 87.33	.531 13.49	21.5 9.7	3.152 80.06	.674 17.12	25 11
5	125	5.563 141	4.88 124	4.88 124	4.313 109.6	.625 15.88	37 17	4.063 103.2	.750 19.05	40 18
6	150	6.625 188	5.62 143	5.62 143	5.187 131.8	.719 18.26	63 28	4.897 124.4	.864 21.95	66 30
8	200	8.625 219	7.00 178	7.00 178	6.813 173.1	.906 23.01	114 51	6.875 174.6	.875 22.23	120 54
10	250	10.750 273	8.50 216	8.50 216	8.500 215.9	1.125 28.58	265 119	- -	- -	- -
12	300	12.750 324	10.00 254	10.00 254	10.126 257.2	1.312 33.32	389 175	- -	- -	- -
14	350	14.000 356	11.00 279	11.00 279	11.188 284.2	1.406 35.71	525 236	- -	- -	- -
16	400	16.000 406	12.00 305	12.00 305	12.812 325.4	1.594 40.49	820 369	- -	- -	- -

INCHES
MILLIMETRES

POUNDS
KILOGRAMS

*REDUCING TEES & REDUCERS

Concentric and Eccentric
Standard Weight, Extra Strong,
Schedule 160,
Double Extra Strong
Carbon and ferritic alloy steel,
ASTM A-234, ASME/ANSI B16.9

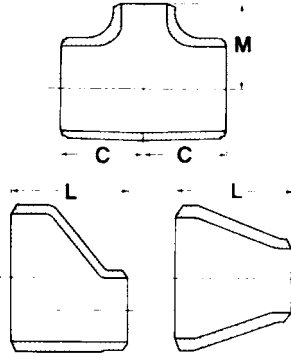

Run	Outlet or Reduced End		Nominal Center-to-End Tees		Nominal Length of Reducers	APPROXIMATE WEIGHTS							
	NPS	DN	Run	Outlet		STANDARD WEIGHT		EXTRA STRONG		SCHEDULE 160		DOUBLE EXTRA STRONG	
						Tee	Reducer	Tee	Reducer	Tee	Reducer	Tee	Reducer
1/2	15	△1/4	1.00	1.00	-	.25	-	.27	-	-	-	-	-
		6	25	25	-	.11	-	.12	-	-	-	-	-
		△3/8	1.00	1.00	-	.25	-	.28	-	-	-	-	-
		10	25	25	-	.11	-	.13	-	-	-	-	-
3/4	20	#△3/8	1.12	1.12	□ 1.5	.37	.22	.43	.24	.63	.27	-	-
		10	29	29	38	.17	0.1	.20	.11	.29	.12	-	-
		1/2	1.12	1.12	1.5	.37	.25	.44	.25	.63	.29	1.12	-
		15	29	29	38	.17	0.1	.20	.11	.29	.13	.51	-
1	25	3/8	1.50	1.50	2.0	.60	.27	.75	.31	.90	.31	-	2.50
		10	38	38	51	.25	0.1	.34	.14	.41	.14	-	1.13
		1/2	1.50	1.50	2.0	.65	.30	.75	.33	.90	.6	1.14	2.50
		15	38	38	51	.27	0.14	.34	.15	.41	.16	.52	1.13
		3/4	1.50	1.50	2.0	.69	.32	.80	.36	1.00	.41	1.19	2.60
		20	38	38	51	.31	0.15	.40	.16	.45	.19	.54	1.18
1 1/4	32	1/2	1.88	1.88	2.0	1.3	.34	1.65	.42	1.67	.46	1.95	2.61
		15	48	48	51	.59	0.15	.75	.19	.76	.21	.88	1.18
		3/4	1.88	1.88	2.0	1.2	.37	1.66	.46	1.68	.51	2.02	2.72
		20	48	48	51	.54	0.17	.75	.21	.76	.23	.92	1.23
		1	1.88	1.88	2.0	1.2	.39	1.90	.49	2.00	.59	2.14	2.894
		25	48	48	51	.54	0.18	.86	.22	.91	.27	.97	1.94
1 1/2	40	1/2	2.25	2.25	2.5	2.1	.44	2.2	.52	2.41	.66	2.84	2.90
		15	57	57	64	.95	0.2	1.00	.24	1.09	.30	1.29	1.32
		3/4	2.25	2.25	2.5	1.8	.47	2.3	.55	2.49	.74	2.93	2.96
		20	57	57	64	.82	0.21	1.04	.25	1.13	.34	1.33	1.34
		1	2.25	2.25	2.5	1.7	.50	.4	.61	2.60	.81	3.08	2.99
		25	57	57	64	.77	0.23	1.10	.28	1.18	.37	1.40	1.36
		1 1/4	2.25	2.25	2.5	1.7	.58	2.6	.66	2.90	.90	3.26	3.02
		32	57	57	64	.77	0.26	1.18	.30	1.32	.41	1.48	1.37
2	50	3/4	2.50	1.75	3.0	2.0	.82	2.7	.89	3.35	1.30	4.26	3.06
		20	64	44	76	.91	.37	1.22	.40	1.52	.59	1.93	1.39
		1	2.50	2.00	3.0	2.0	.89	2.7	.90	3.60	1.52	4.41	3.12
		25	64	51	76	.91	.40	1.22	.41	1.63	.69	2.00	1.42
		1 1/4	2.50	2.25	3.0	2.1	.94	2.8	1.02	3.75	1.78	4.65	3.20
		32	64	57	76	.95	.43	1.27	.46	1.70	.81	2.11	1.45
		1 1/2	2.50	2.38	3.0	2.2	1.03	2.8	1.20	3.90	1.84	5.18	3.31
		40	64	60	76	1.00	.47	1.27	.54	1.77	.83	2.35	1.50
2 1/2	65	1	3.00	2.25	3.5	3.0	1.42	4.2	1.55	5.90	2.10	8.00	3.40
		25	76	57	89	1.36	.64	1.91	.70	2.68	.95	3.63	1.54
		1 1/4	3.00	2.50	3.5	3.2	1.59	4.3	1.75	6.00	2.31	8.40	3.46
		32	76	64	89	1.45	.72	1.95	.79	2.72	1.05	3.81	1.57
		1 1/2	3.00	2.62	3.5	3.5	1.71	4.5	2.02	6.20	2.43	9.13	3.52
		40	76	67	89	1.60	.78	2.04	.92	2.81	1.10	4.14	1.60
		2	3.00	2.75	3.5	3.5	1.84	4.5	2.25	6.60	2.59	9.18	3.64
		50	76	70	89	1.60	2.5	2.04	1.02	3.00	1.17	4.16	1.65
3	80	#△1	3.38	2.62	□ 3.5	5.0	2.10	6.0	2.45	-	-	-	-
		25	86	67	89	2.27	1.0	2.72	1.11	-	-	-	-
		1 1/4	3.38	2.75	3.5	5.1	2.28	6.0	2.60	9.20	2.91	12.0	3.75
		32	86	70	89	2.31	1.0	2.72	1.18	4.17	1.32	5.4	1.70
		1 1/2	3.38	2.88	3.5	5.1	2.42	6.12	2.70	9.35	3.10	12.2	3.9
		40	86	73	89	2.31	1.1	2.81	1.22	4.24	1.41	5.5	1.77
		2	3.38	3.00	3.50	5.2	2.56	6.4	2.75	9.68	3.43	12.5	4.00
		50	86	76	89	2.36	1.16	2.95	1.25	4.4	1.6	5.7	1.8

CONTINUED ON PAGES 17, 18, 19
REFER TO PAGE 19 FOR FOOTNOTES.
For ordering information see page 19.

INCHES	POUNDS
MILLIMETRES	KILOGRAMS

***REDUCING TEES & REDUCERS CONCENTRIC AND ECCENTRIC continued**

Run	Outlet or Reduced End		Nominal Center-to-End Tees		Nominal Length of Reducers	APPROXIMATE WEIGHTS							
						STANDARD WEIGHT		EXTRA STRONG		SCHEDULE 160		DOUBLE EXTRA STRONG	
						NPS	DN	Run	Outlet	Tee	Reducer	Tee	Reducer
	2 1/2	65	3.38	3.25	3.5	6.0	2.64	7.5	2.90	10.20	3.75	13.5	4.25
			86	83	89	2.72	1.20	3.40	1.32	4.6	1.7	6.1	1.9
3 1/2	#1 14	32	-	-	□ 4.00	7.5	2.68	-	3.10	-	-	-	4.72
	90		-	-	102	3.40	68.1	-	78.7	-	-	-	119.9
	1 1/2	40	3.75	3.12	4.00	7.5	2.72	11.0	3.20	-	-	16.3	5.30
			95	79	102	3.40	1.23	5.0	1.45	-	-	7.4	2.4
	2	50	3.75	3.25	4.00	8.2	2.77	11.2	3.35	-	-	16.7	5.64
			95	83	102	3.72	1.26	5.1	1.52	-	-	7.6	2.6
	2 1/2	65	3.75	3.50	4.00	8.3	2.82	12.0	3.50	-	-	17.5	5.92
			95	89	102	3.76	1.28	5.4	1.59	-	-	7.9	2.7
	3	80	3.75	3.62	4.00	9.5	2.88	12.6	4.00	-	-	18.5	6.20
			95	92	102	4.31	1.31	5.7	1.81	-	-	8.4	2.8
4	#△1	25	-	-	□ 4.00	12.0	2.91	-	4.10	-	-	-	-
	100		-	-	102	5.44	73.9	-	104.1	-	-	-	-
	1 1/2	40	4.12	3.38	4.00	12.0	2.94	13.0	4.30	16.8	5.40	21.5	6.53
			105	86	102	5.44	1.33	5.9	1.95	7.6	2.5	9.8	3.0
	2	50	4.12	3.50	4.00	9.4	2.97	13.0	4.50	17.2	5.59	22.0	6.72
			105	89	102	4.26	1.35	5.9	2.04	7.8	2.5	10.0	3.1
	2 1/2	65	4.12	3.75	4.00	9.4	3.02	13.6	4.60	17.7	5.64	22.7	6.89
			105	95	102	4.26	1.37	6.2	2.1	8.0	2.6	10.3	3.1
	3	80	4.12	3.88	4.00	9.5	3.08	14.2	4.75	18.5	5.81	23.3	7.10
			105	98	102	4.31	1.40	6.4	2.2	8.4	2.6	10.6	3.2
	3 1/2	90	4.12	4.00	4.00	10.0	3.12	14.9	4.90	-	-	24.5	7.40
			105	102	102	4.35	1.42	6.8	2.2	-	-	11	3.4
5	2	50	4.88	4.12	5.00	14.5	3.28	18.0	5.30	30.5	7.95	35.6	10.5
			124	105	127	6.6	1.49	8.1	2.4	13.8	3.6	16.2	4.8
	2 1/2	65	4.88	4.25	5.00	14.5	3.36	18.2	5.50	31.0	9.00	36.2	12.2
			124	108	127	6.6	1.52	8.3	2.5	14.1	4.1	16.4	5.5
	3	80	4.88	4.38	5.00	14.5	3.55	18.8	5.75	31.7	10.5	37.2	13.7
			124	111	127	6.6	1.61	8.5	2.6	14.4	4.8	17	6.2
	3 1/2	90	4.88	4.50	5.00	15.0	3.69	20.0	6.10	-	-	38.0	14.9
			124	114	127	6.8	1.67	9.1	2.8	-	-	17	6.8
	4	100	4.88	4.62	5.00	15.1	3.81	22.5	6.50	33.2	11.7	39.0	15.5
			124	117	127	6.9	1.74	10.2	3.0	15.1	5.3	18	7.0
6	#△2	50	5.62	4.75	□ 5.50	19.5	4.28	30	7.75	45.5	-	53.0	-
			143	121	140	8.9	1.94	13.6	3.5	20.6	-	24	-
	2 1/2	65	5.62	4.75	5.50	20.0	4.40	31	8.25	48.2	13.0	56.6	17.5
			143	121	140	9.1	2.00	14.1	3.7	21.9	5.9	26	7.9
	3	80	5.62	4.88	5.50	21.0	4.64	31.5	8.75	48.9	15.0	57.5	18.2
			143	124	140	9.5	2.10	14.3	4.0	22.2	6	26	8.3
	3 1/2	90	5.62	5.00	5.50	21.5	4.81	32.0	9.50	-	-	58.5	19.0
			143	127	140	9.8	2.18	14.5	4.3	-	-	27	8.6
	4	100	5.62	5.12	5.50	21.5	5.06	32.5	11.00	50.5	17.5	59.3	19.7
			143	130	140	9.8	2.30	14.7	5.0	22.9	7.9	27	8.9
	5	125	5.62	5.38	5.50	23	5.32	33.0	12.00	52.6	19.1	62.1	21.0
			143	137	140	10.4	2.41	15	5.4	23.9	7	28	9.5
8	#△3	80	7.00	6.00	□ 6.00	38	7.29	63	14.50	-	28.5	-	25.7
			178	152	152	17.2	3.31	29	6.6	-	12.9	-	11.7
	3 1/2	90	7.00	67.00	6.00	39	7.65	63	16.0	-	-	96.5	27.1
			178	152	152	17.7	3.47	29	7.3	-	-	44	12.3
	4	100	7.00	6.12	6.00	40.5	8.12	64	16.5	98.7	33.0	97.5	28.5
			178	156	152	18.4	3.68	29	7.5	44.8	15.0	44	13
	5	125	7.0	6.38	6.0	41.0	8.53	65	17.0	101	37.0	100	29.7
			178	162	152	18.6	3.8	30	7.7	46	17	45.5	13.5
	6	150	7.0	6.62	6.0	44.0	9.02	65	18.5	104	41.0	104	33.0
			178	168	152	20	4.1	30	8.4	47	19	47	15
10	#△3	80	8.5	7.25	□ 7.0	72.0	11.0	90	21.0	181	-	-	-
			216	184	178	32	5.0	41	9.5	82	-	-	-
	4	100	8.5	7.25	7.0	75.0	12.5	92	23.0	183	45.0	-	41.0
			216	184	178	34	5.6	41	10.4	83	20.5	-	19
	5	125	8.5	7.50	7.0	75.0	15.0	96	25.0	190	49.0	-	44.0
			216	191	178	34	6.8	43	11.3	86	22	-	20
	6	150	8.5	7.62	7.0	79.0	17.0	98	28.0	193	53.0	-	48.0
			216	194	178	36	7.7	44	12.7	88	24	-	22
	8	200	8.5	8.00	7.0	79.2	21.0	100	29.5	208	59.0	-	52.0
			216	203	178	36	9.5	45	13.4	94	27	-	24

*Wall thickness and other pipe size data are in accordance with ASME/ANSI B36.10M. Refer to page 6. For ordering information see page 19.

INCHES	POUNDS
MILLIMETRES	KILOGRAMS

REDUCING TEES & REDUCERS CONCENTRIC AND ECCENTRIC continued

NPS	Outlet or Reduced End		Nominal Center-to-End Tees		Nominal Length of Reducers	APPROXIMATE WEIGHTS								
	NPS	DN	Run	Outlet		STANDARD WEIGHT		EXTRA STRONG		SCHEDULE 160		DOUBLE EXTRA STRONG		
			C	M		Tee	Reducer	Tee	Reducer	Tee	Reducer	Tee	Reducer	
12	300	#4	10.0	8.50	8.0	101	23.0	132	32	301	-	-	-	
			254	216	203	46	10.4	59	14.5	137	-	-	-	
		5	100	10.0	8.50	8.0	105	25.0	134	33	305	72.0	-	67.0
				254	216	203	47	11.3	60	15	139	32.5	-	30
		6	125	10.0	8.63	8.0	105	28.0	136	34	308	75.0	-	69.0
				254	219	203	47	12.6	61	15.5	140	34	-	31
		8	150	10.0	9.00	8.0	105	30.0	140	36	315	83.0	-	72.0
				254	229	203	47	13.5	63	16	143	38	-	33
		10	200	10.0	9.50	8.0	130	32.0	148	39	332	94.0	-	75.0
				254	241	203	59	14.4	67	18	151	43	-	34
14	350	△6	11.0	9.38	13.0	146	58.0	184	59	410	110	-	-	
			279	238	330	66	26	83	27	186	50	-	-	
		8	150	11.0	9.75	13.0	147	59.5	187	61	435	125	-	-
				279	248	330	66	27	84	28	197	57	-	-
		10	200	11.0	10.13	13.0	149	61.0	190	62	470	137	-	-
				29	257	330	67	27	86	28	213	62	-	-
		12	250	11.0	10.63	13.0	152	64.0	196	75	495	153	-	-
				279	270	330	68	29	88	34	225	69	-	-
	16	400	△6	12.0	10.38	14.0	179	-	231	-	540	-	-	-
				305	264	356	81	-	104	-	245	-	-	-
		8	150	12.0	10.75	14.0	186	69.0	236	89	565	168	-	-
				305	273	356	84	31	106	40	256	76	-	-
		10	200	12.0	11.13	14.0	196	72.0	248	95	610	190	-	-
				305	283	356	88	32	111	43	277	86	-	-
		12	250	12.0	11.63	14.0	211	75.0	259	101	675	220	-	-
				305	295	356	95	34	117	48	340	120	-	-
		14	300	12.0	12.00	14.0	219	80	261	106	750	265	-	-
				305	305	356	99	36	117	48	340	120	-	-
18	450	△8	13.5	11.75	15.0	236	-	302	-	-	-	-	-	
			343	298	381	106	-	136	-	-	-	-	-	
		10	200	13.5	12.13	15.0	249	81	311	112	-	-	-	
				343	308	381	112	36	140	51	-	-	-	
		12	250	13.5	12.63	15.0	261	82	332	115	-	-	-	
				343	321	381	117	37	149	52	-	-	-	
		14	300	13.5	13.00	15.0	270	84	340	117	-	-	-	
				343	330	381	122	38	153	53	-	-	-	
		16	350	13.5	13.00	15.0	282	85	352	119	-	-	-	
				343	330	381	127	38	158	54	-	-	-	
20	500	△8	15.0	12.75	20.0	294	-	379	-	-	-	-	-	
			381	324	508	133	-	172	-	-	-	-	-	
		△10	200	15.0	13.13	20.0	307	-	385	-	-	-	-	
				381	333	508	139	-	175	-	-	-	-	
		12	250	15.0	13.63	20.0	316	110	401	149	-	-	-	
				381	346	508	143	50	182	68	-	-	-	
		14	300	15.0	14.00	20.0	329	117	418	153	-	-	-	
				381	356	508	149	53	190	69	-	-	-	
		16	350	15.0	14.00	20.0	341	123	432	158	-	-	-	
				381	356	508	155	56	196	72	-	-	-	
	18	400	15.0	14.50	20.0	355	126	449	165	-	-	-		
			381	368	508	161	57	204	75	-	-	-		
22	550	△10	16.5	14.13	20.0	366	-	471	-	-	-	-		
			419	359	508	166	-	214	-	-	-	-		
		△12	250	16.5	14.63	20.0	382	-	479	-	-	-		
				419	371	508	173	-	217	-	-	-		
		14	300	16.5	15.00	20.0	395	128	487	168	-	-		
				419	381	508	179	58	221	76	-	-		
		16	350	16.5	15.00	20.0	412	133	499	171	-	-		
				419	381	508	187	60	226	78	-	-		
		18	400	16.5	15.50	20.0	429	140	522	175	-	-		
				419	394	508	195	64	237	79	-	-		
	20	450	16.5	16.00	20.0	443	143	540	181	-	-			
			419	406	508	201	65	245	82	-	-			
24	600	△10	17.0	15.13	20.0	451	149	556	183	-	-			
			43	384	508	25	68	252	83	-	-			
		△12	250	17.0	15.63	20.0	455	152	562	187	-	-		
				432	397	508	206	69	255	85	-	-		
		△14	300	17.0	16.00	20.0	268	154	571	191	-	-		
				432	406	508	12	70	259	87	-	-		
	16	350	17.0	16.00	20.0	479	156	585	194	-	-			
			432	406	508	217	71	285	88	-	-			

REDUCING TEES & REDUCERS CONCENTRIC AND ECCENTRIC continued

NPS	Outlet or Reduced End		Nominal Center-to-End Tees		Nominal Length of Reducers L	APPROXIMATE WEIGHTS							
	NPS	DN	Run	Outlet		STANDARD WEIGHT		EXTRA STRONG		SCHEDULE 160		DOUBLE EXTRA STRONG	
			C	M		Tee	Reducer	Tee	Reducer	Tee	Reducer	Tee	Reducer
24	600	18	17.0	16.50	20.0	490	160	597	198	-	-	-	-
		450	432	419	508	222	73	271	90	-	-	-	-
		20	17.0	17.00	20.0	506	165	614	205	-	-	-	-
		500	432	432	508	230	75	279	93	-	-	-	-
26	650	#^12	19.5	16.63	□ 24.0	534	-	665	-	-	-	-	-
		300	495	422	610	242	-	302	-	-	-	-	-
		△14	19.5	17.00	□ 24.0	547	-	679	-	-	-	-	-
		350	495	432	610	248	-	308	-	-	-	-	-
		△16	19.5	17.00	24.0	561	-	691	-	-	-	-	-
		400	495	432	610	254	-	313	-	-	-	-	-
		18	19.5	17.50	24.0	575	170	714	215	-	-	-	-
		450	495	444	610	261	77	324	98	-	-	-	-
		20	19.5	18.00	24.0	592	172	733	221	-	-	-	-
		500	495	457	610	268	78	332	100	-	-	-	-
		22	19.5	18.50	24.0	623	174	756	229	-	-	-	-
		550	495	470	610	283	79	343	104	-	-	-	-
		24	19.5	19.00	24.0	643	177	780	235	-	-	-	-
		600	495	483	610	292	80	354	107	-	-	-	-
30	750	△14	22.0	19.0	□ 24.0	675	-	865	-	-	-	-	-
		350	559	483	610	305	-	392	-	-	-	-	-
		△16	22.0	19.0	□ 24.0	690	-	895	-	-	-	-	-
		400	559	483	610	313	-	406	-	-	-	-	-
		△18	22.0	19.5	□ 24.0	721	-	932	-	-	-	-	-
		450	559	495	610	327	-	423	-	-	-	-	-
		20	22.0	20.0	□ 24.0	744	180	978	264	-	-	-	-
		500	559	508	610	337	82	444	120	-	-	-	-
		22	22.0	20.5	24.0	768	200	1031	270	-	-	-	-
		550	559	521	610	348	91	468	122	-	-	-	-
		24	22.0	21.0	24.0	792	215	1050	275	-	-	-	-
		600	559	533	610	359	98	476	125	-	-	-	-
		26	22.0	21.5	24.0	845	235	1085	282	-	-	-	-
		650	559	546	610	383	107	492	128	-	-	-	-
36	900	△16	26.5	22.0	□ 24.0	1280	-	1220	-	-	-	-	-
		400	673	559	610	581	-	553	-	-	-	-	-
		△18	26.5	22.5	□ 24.0	1305	-	1310	-	-	-	-	-
		450	673	572	610	592	-	594	-	-	-	-	-
		△20	26.5	23.0	□ 24.0	1360	319	1395	320	-	-	-	-
		500	673	584	610	617	141	633	145	-	-	-	-
		△22	26.5	23.5	□ 24.0	1390	-	146	-	-	-	-	-
		550	673	597	610	631	-	665	-	-	-	-	-
		24	26.5	24.0	24.0	1410	340	1510	360	-	-	-	-
		600	673	610	610	640	154	685	163	-	-	-	-
		26	26.5	24.5	24.0	1425	-	1555	-	-	-	-	-
		650	673	622	610	646	-	705	-	-	-	-	-
		30	26.5	25.0	24.0	1432	375	1595	385	-	-	-	-
		750	673	635	610	650	170	723	175	-	-	-	-
42	1100	△18	30.0	25.5	24.0	1550	-	1770	-	-	-	-	-
		450	762	648	610	703	-	803	-	-	-	-	-
		△20	30.0	26.0	24.0	1590	-	1810	-	-	-	-	-
		500	762	660	610	721	-	821	-	-	-	-	-
		△22	30.0	26.0	24.0	1630	-	1850	-	-	-	-	-
		550	762	660	610	739	-	839	-	-	-	-	-
		△24	30.0	26.0	24.0	1645	390	1865	405	-	-	-	-
		600	762	660	610	745	177	846	184	-	-	-	-
		△26	30.0	27.5	24.0	1665	425	1890	440	-	-	-	-
		650	762	698	610	755	193	857	200	-	-	-	-
		30	30.0	28.0	□ 24.0	1690	445	1910	465	-	-	-	-
		750	762	711	610	767	202	866	211	-	-	-	-
		36	30.0	28.0	□ 24.0	1710	470	1935	495	-	-	-	-
		900	762	711	610	776	213	878	225	-	-	-	-

When ordering Reducing Tees, specify the run pipe size first, followed by the outlet size. Example 2 x 2 x 1.

When ordering Reducers, specify the Large End first, followed by the Small End size and the type. Example: 2 x 1 eccentric.

These fittings are also available in other sizes and/or wall thicknesses.

Wall thickness and other pipe size data are in accordance with ASME/ANSI B36.10M. Refer to page 6.

#This size of Reducing Outlet Tee is not covered in ANSI B16.9

△ This size of Reducer is not covered in ANSI B16.9

□ This size of Reducer supplied concentric, only.

Tees size 20 NPS (DN 500) and smaller, and Reducers size 24 NPS (DN 600) and smaller, are normally furnished as seamless. Larger size non-seamless Tees and Reducers are produced from X-rayed, stress relieved welded pipe. Welds are 100% radiographed in accordance with the requirements of the ASME Boiler & Pressure Vessel Code.

INCHES	POUNDS
MILLIMETRES	KILOGRAMS

CAPS

Standard, Extra Strong,
Schedule 160,
Double Extra Strong
Carbon and ferritic alloy steel,
ASTM A-234
ASME/ANSI B16.9

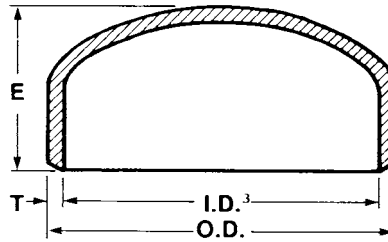

NPS	DN	Outside Diameter at Bevel O.D.	STANDARD WEIGHT			EXTRA STRONG			SCHEDULE 160			DOUBLE EXTRA STRONG		
			Wall Thickness T	Nominal Length (1) E	Approx. Weight	Wall Thickness T	Nominal Length (1) E	Approx. Weight	Wall Thickness T	Nominal Length (1) E	Approx. Weight	Wall Thickness T	Nominal Length (1) E	Approx. Weight
1/2	15	.840	.109	1.0	.1	.147	1.0	.09	-	-	-	-	-	-
		21	2.77	25	.05	3.73	25	.04	-	-	-	-	-	-
3/4	20	1.050	.113	1.0	.1	.154	1.0	.1	-	-	-	-	-	-
		27	2.87	25	.05	3.91	25	.05	-	-	-	-	-	-
1	25	1.315	.133	1.5	.2	.179	1.5	.2	.250	1.5	.4	.38	1.5	1.0
		33	3.38	38	.09	4.55	38	.09	6.35	38	.2	9.09	38	.45
1 1/4	32	1.660	.140	1.5	.3	.191	1.5	.4	.250	1.5	.5	.382	1.5	1.5
		42	3.56	38	.14	4.85	38	.18	6.35	38	.2	9.70	38	.68
1 1/2	40	1.900	.145	1.5	.4	.200	1.5	.5	.281	1.5	.6	.400	1.5	2.5
		48	3.68	38	.18	5.08	38	.23	7.14	38	.3	10.16	38	1.1
2	50	2.375	.154	1.5	.6	.218	1.5	.8	.344	1.75	1.25	.436	1.75	3.0
		60	3.91	38	.27	5.54	38	.36	8.74	44	.6	11.07	44	1.4
2 1/2	65	2.875	.203	1.5	.9	.276	1.5	1.0	.375	2.0	1.75	.552	2.0	4.0
		73	5.16	38	.41	7.01	38	.45	9.53	51	.8	14.02	51	1.8
3	80	3.500	.216	2.0	1.4	.300	2.0	2.0	.438	2.5	2.9	.600	2.5	6.0
		89	5.49	51	.64	7.62	51	.91	11.13	64	1.3	15.24	64	2.7
3 1/2	90	4.000	.226	2.5	2.2	.318	2.5	2.8	-	-	-	(2).636	3.0	7.5
		102	5.74	64	1.0	8.08	64	1.3	-	-	-	(2)16.15	76	3.4
4	100	4.500	.237	2.5	3.0	.337	2.5	3.5	.531	3.0	5.9	.674	3.0	9.0
		114	6.02	64	1.4	8.56	64	1.6	13.49	76	2.7	17.12	76	4.1
5	125	5.563	.258	3.0	4.5	.375	3.0	5.8	.625	3.5	10	.750	3.5	13.5
		141	6.55	78	2.0	9.53	76	2.6	15.88	89	4.5	19.05	89	5.1
6	150	6.625	.280	3.5	7.2	.432	3.5	9.2	.719	4.0	15	.864	4.0	18
		168	7.11	89	3.3	10.97	89	4.2	18.26	102	6.8	21.95	102	8.2
8	200	8.625	.322	4.0	12.0	.500	4.0	15	.906	5.0	31	.875	5.0	26
		219	8.18	102	5.4	12.70	102	6.8	23.01	127	14	22.23	127	12
10	250	10.750	.365	5.0	18	.500	5.0	25	1.125	6.0	57	-	-	-
		273	9.27	127	8.2	12.70	127	11.3	28.58	152	26	-	-	-
12	300	12.750	.375	6.0	27	.500	6.0	35	1.312	7.0	95	-	-	-
		324	9.53	152	12	12.70	152	16	33.32	178	43	-	-	-
14	350	14.000	.375	6.5	33	.500	6.5	43	1.406	7.5	130	-	-	-
		356	9.53	165	15	12.70	185	20	35.71	191	59	-	-	-
16	400	16.000	.375	7.0	42	.500	7.0	54	1.594	8.0	165	-	-	-
		405	9.53	178	19	12.70	178	25	40.49	203	75	-	-	-
18	450	18.000	.375	8.0	55	.500	8.0	73	-	-	-	-	-	-
		457	9.53	203	25	12.70	203	33	-	-	-	-	-	-
20	500	20.000	.375	9.0	68	.500	9.0	90	-	-	-	-	-	-
		508	9.53	229	31	12.70	229	41	-	-	-	-	-	-
22	550	22.000	.375	10.0	86	.500	10.0	110	-	-	-	-	-	-
		559	9.53	254	39	12.70	254	50	-	-	-	-	-	-
24	600	24.000	.375	10.5	96	.500	10.5	127	-	-	-	-	-	-
		610	9.53	267	44	12.70	267	58	-	-	-	-	-	-
26	650	26.000	.375	10.5	110	.500	10.5	145	-	-	-	-	-	-
		680	9.53	267	50	12.70	267	66	-	-	-	-	-	-
30	750	30.000	.375	10.5	132	.500	10.5	175	-	-	-	-	-	-
		762	9.53	267	60	12.70	267	79	-	-	-	-	-	-
36	900	36.000	.375	10.5	192	.500	10.5	235	-	-	-	-	-	-
		914	9.53	267	87	12.70	267	107	-	-	-	-	-	-
42	1100	42.000	.375	12.0	225	.500	12.0	295	-	-	-	-	-	-
		1067	9.53	305	102	12.70	305	134	-	-	-	-	-	-

(1) See page 5 for Dimensional tolerances.
 (2) This size not covered in ASME/ANSI B36.10M. dimensions of wrought steel pipe.
 (2) For inside diameter, refer to page 6.
 These fittings are also available in other sizes and/or wall thicknesses.

INCHES	POUNDS
MILLIMETRES	KILOGRAMS

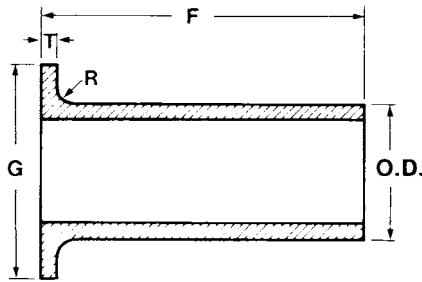

LAP JOINT STUB ENDS

Standard Weight
and Extra Strong
Carbon and ferritic alloy steel,
ASTM A-234, ASME/ANSI B16.9

NPS	DN	Nominal Outside Diameter of Barrel O.D.	Nominal Length F	Radius R Nom. & Max.	Nom. & Max. Diameter of Lap G	STANDARD WEIGHT		EXTRA STRONG	
						Lap and Wall Thickness (1) T	Approx. Weight	Lap and Wall Thickness (1) T	Approx. Weight
1/2		0.84	3.0	.12	1.38	.109	.35	1.47	.45
	15	21.4	76	3	35	2.77	.16	3.73	.2
3/4		1.05	3.0	.12	1.69	.113	.50	.154	.70
	20	26.7	76	3	43	2.87	.23	3.91	.3
1		1.32	4.0	.12	2.00	.133	.65	.179	1.0
	25	33.4	102	3	51	3.38	.29	4.55	.45
1 1/4		1.66	4.0	.19	2.50	.140	1.0	.191	1.4
	32	42.2	102	5	64	3.56	.45	4.85	.6
1 1/2		1.90	4.0	.25	2.88	.145	1.2	.200	1.6
	40	48.3	102	6	73	3.68	.54	5.08	.7
2		2.38	6.0	.31	3.62	.154	2.3	.218	3.0
	50	60.4	152	8	92	3.91	1.0	5.54	1.4
2 1/2		2.88	6.0	.31	4.12	.203	3.4	.176	4.5
	65	73.1	152	8	105	5.16	1.5	7.01	2.0
3		3.50	6.0	.38	5.00	.216	4.7	.300	6.3
	80	88.9	152	10	127	5.49	2.1	7.62	2.9
3 1/2		4.00	6.0	.38	5.50	.226	5.6	.318	7.4
	90	101.6	152	10	140	5.64	2.5	8.08	3.4
4		4.50	6.0	.44	6.19	.237	6.7	.337	9.0
	100	114.3	152	11	157	6.02	3.0	8.56	4.1
5		5.56	8.0	.44	7.31	.258	11.8	.375	16.5
	125	141.3	203	11	186	6.55	5.4	9.53	7.5
6		6.62	8.0	.50	8.50	.280	16.1	.432	22.5
	150	168.3	203	13	216	7.11	7.3	10.97	10
8		8.62	8.0	.50	10.62	.322	25.5	.500	34.5
	200	219.1	203	13	270	8.18	11.6	12.70	16
10		10.75	10.0	.50	15.00	.375	47	.500	64.5
	250	273.1	254	13	324	9.27	18	12.70	24
12		12.75	10.0	.50	15.00	.375	47	.500	64.5
	300	323.9	254	13	381	9.53	21	12.70	29
14		14.00	12.0	.50	16.25	.375	61	.500	83
	350	355.6	305	13	413	9.58	28	12.70	38
16		16.00	12.0	.50	18.50	.375	74	.500	95
	400	406.4	305	13	470	9.53	34	12.70	43
18		18.00	12.0	.50	21.00	.375	85	.500	108
	450	457.2	305	13	533	9.53	39	12.70	49
20		20.00	12.0	.50	23.00	.375	96	.500	138
	500	508.0	305	13	584	9.53	44	12.70	63
24		24.00	12.0	.50	27.25	.375	126	.500	167
	600	609.6	305	13	692	9.53	57	12.70	76

See page 5 for dimensional tolerances.

(1) The basic minimum lap thickness shall not be less than the nominal pipe wall thickness.

INCHES
MILLIMETRES

POUNDS
KILOGRAMS

SADDLES

Carbon and ferritic alloy steel,
 ASTM A-234
 A-515 Gr. 70
 A-106 Gr. B

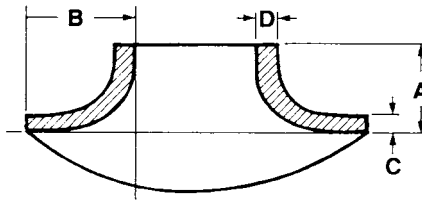

Nominal Size of Nozzle	Nominal Header Size	STANDARD WEIGHT				Approx. Weight
		A	B	C	D	
NPS	NPS					
DN	DN					
1/4	1/4 - 48	.63	.75	.19	.22	.5
6	6 - 1200	16	19	4.8	5.6	.23
1/2	1/2 - 48	.81	.88	.19	.22	.5
15	15 - 1200	21	22	4.8	5.6	.23
3/4	3/4 - 48	.81	1.25	.19	.22	.75
20	20 - 1200	21	32	4.8	5.6	.34
1	1 - 48	.88	1.31	.19	.22	1.0
25	25 - 1200	22	33	4.8	5.6	.45
1 1/4	1 1/4 - 48	1.25	1.38	.19	.22	1.0
32	32 - 1200	32	35	4.8	5.6	.45
1 1/2	1 1/2 - 48	1.50	1.75	.25	.31	2.0
40	40 - 1200	38	44	6.4	7.9	.90
2	2 - 48	1.50	2.00	.25	.31	3.0
50	50 - 1200	38	51	6.4	7.9	1.35
2 1/2	2 1/2 - 48	1.63	2.13	.28	.31	4.0
65	65 - 1200	41	54	7.1	7.9	1.80
3	3 - 48	1.50	2.25	.31	.41	5.0
80	80 - 1200	38	57	7.9	10.4	2.25
3 1/2	3 1/2 - 48	1.75	2.25	.31	.41	6.0
90	90 - 1200	44	57	7.9	10.4	2.70
4	4 - 48	1.75	2.50	.38	.38	7.0
100	100 - 1200	44	64	7.9	9.7	3.15
5	5 - 48	2.00	3.00	.38	.44	12.0
125	125 - 1200	51	76	9.7	11.2	5.40
6	6 - 48	2.50	3.75	.44	.50	22.0
150	150 - 1200	64	95	11.2	12.7	10
8	8 - 48	2.75	4.25	.44	.50	33.0
200	200 - 1200	70	108	11.2	12.7	15
10	10 - 48	3.00	5.00	.44	.50	45.0
250	250 - 1200	76	127	11.2	12.7	20
12	12 - 48	3.50	5.50	.44	.50	57.0
300	300 - 1200	89	140	11.2	12.7	26
14	14 - 48	4.00	6.00	.44	.50	76
350	350 - 1200	102	152	11.2	12.7	34
16	16 - 48	4.00	7.50	.44	.56	107
400	400 - 1200	102	191	11.2	14.2	48
18	18 - 48	4.25	8.00	.50	.63	152
450	450 - 1200	108	203	12.7	16.0	69
20	20 - 48	5.25	8.00	.50	.63	163
500	500 - 1200	133	203	12.7	16.0	73
24	24 - 48	6.00	9.50	.50	.63	248
600	600 - 1200	152	241	12.7	16.0	112

Saddles are used to reinforce intersecting welded junctions and are not intended to be used as pressure containing fittings. A vent hole prevents pressure build-up of welding gasses between saddle and header. Saddles are made from welding grade seamless steel, and are fully normalized.

INCHES	POUNDS
MILLIMETRES	KILOGRAMS

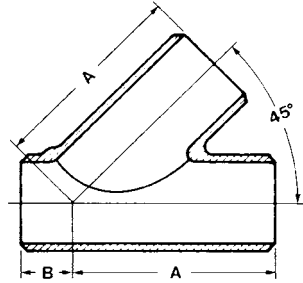
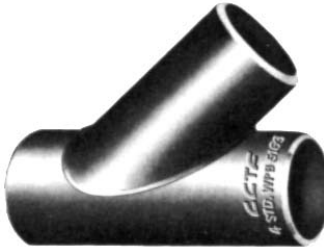

WELDING *LATERALS

Standard Weight
and Extra Strong
Carbon and ferritic alloy steel,

NPS	DN	STANDARD WEIGHT			EXTRA STRONG		
		A	B	Approx. Weight	A	B	Approx. Weight
1	25	5.75	1.75	1.85	6.50	2.00	2.75
		146	45	.83	165	51	1.24
1 1/4	32	6.25	1.75	2.60	7.25	2.25	4.10
		159	45	1.17	184	57	1.85
1 1/2	40	7.00	2.00	3.45	8.50	2.50	5.35
		178	51	1.55	216	64	2.41
2	50	8.00	2.50	4.95	9.00	2.50	7.80
		203	64	2.23	229	64	3.51
2 1/2	65	9.50	2.50	9.5	10.50	2.50	13.7
		241	64	4.28	267	64	6.17
3	80	10.00	3.00	12.0	11.00	3.00	19.2
		245	76	5.40	279	76	8.6
3 1/2	90	11.50	3.00	17.7	12.50	3.00	26.
		292	76	8	318	76	12
4	100	12.00	3.00	19.5	13.50	3.00	34.6
		305	76	9	343	76	16
5	125	13.50	3.50	29.2	15.00	3.50	51.4
		343	89	13	381	89	23
6	150	14.50	3.50	41.7	17.50	4.00	82.3
		368	89	19	445	102	37
8	200	17.50	4.50	77.5	20.50	5.00	135
		445	114	35	521	127	61
10	250	20.50	5.00	13	24.00	5.50	199
		521	127	59	610	140	90
12	300	24.50	5.50	190	27.50	6.00	279
		622	140	86	699	152	126
14	350	27.00	6.00	225	31.00	6.50	344
		686	152	101	787	165	155
16	400	30.00	6.50	290	34.50	7.50	432
		762	165	131	876	191	194
18	450	32.00	7.00	340	37.50	8.00	551
		813	178	153	953	203	248
20	500	35.00	8.00	412	40.50	8.50	637
		889	203	185	1029	216	287
24	600	40.50	9.00	554	47.50	10.00	903
		1029	229	249	1207	254	406

Laterals are fabricated from Grade B standard and extra strong seamless pipe.

The working pressure of any fabricated Lateral must be rated at only 40% of the allowable working pressure established for the pipe from which the lateral is made. Dimensions and price of 100% strength laterals will be furnished on request.

Laterals are also available in other materials, sizes and/or wall thicknesses.

*Reducing laterals can be supplied with the same centre-to-end dimensions as shown above.

INCHES	POUNDS
MILLIMETRES	KILOGRAMS

BUTT WELDING ENDS ASME/ANSI B16.9

For fittings with wall thickness equal to that of the pipe to which they are to be welded.

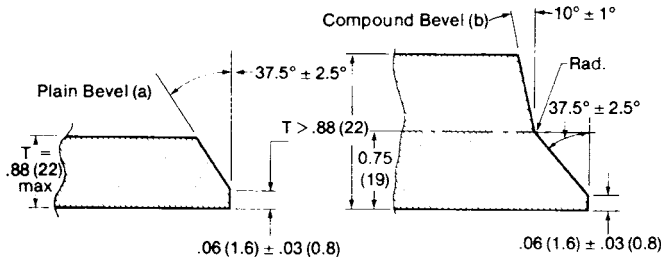

Nominal Wall Thickness (T)	End Preparation
Less than x^*	Cut square or slightly camfer, at mfr's option
x^* to .88 incl. (22)	Plain bevel as in sketch (a).
More than .88 (22)	Compound bevel as in sketch (b).
$x^* = 0.19$ (5) for carbon steel or ferritic alloy steel and 0.12 (4) for austenitic alloy steel.	

Millimetres in brackets.

SIZE RANGES ASME/ANSI B16.9

The following size ranges of Welding Fittings are covered by ANSI B16.9. "Steel Butt-Welding Fittings."

90° Long Radius Elbows	1/2" to 48" incl.
45° Long Radius Elbows	1/2" to 48" incl.
90° Long Radius Reducing Elbows	2" to 24" incl.
Tees, Straight and Reducing Outlets	1/2" to 48" incl.
Crosses, Straight and Reducing Outlets	1/2" to 48" incl.
Welding Caps	1/2" to 48" incl.
Lap-Joint Stub Ends	1/2" to 24" incl.
Welding Reducers	3/4" to 48" incl.
Long Radius Return Bends	1/2" to 24" incl.

Although great care has been taken in compiling the information contained in this catalogue, WESTLUND does not accept responsibility for the consequences of any errors, nor for the effects of any subsequent changes made by the various sources of data.

CATALOGUE SECTION 2